

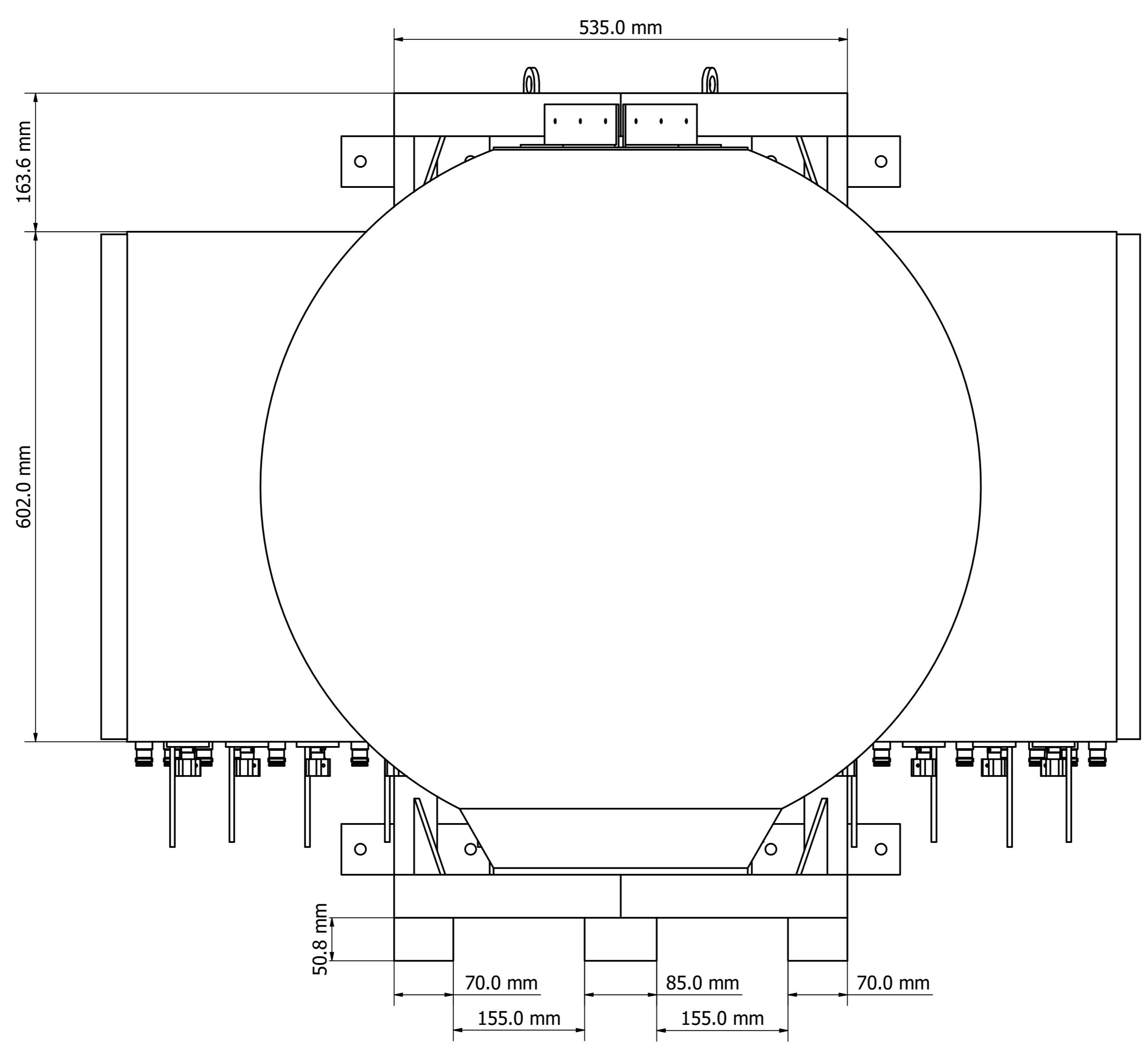

Designed by ALEXANDRE	Drawing by LAWRENCE	Date 5/12/2019	Approved by PAVEL	Date 7/12/2019	Quantity	Material	
<b>MATSING</b> LENS TECHNOLOGY ENABLED						MS-12H90	
MS-12H90 (mm)						Revision 1.0	Sheet 1 / 6



Designed by ALEXANDRE	Drawing by LAWRENCE	Date 5/12/2019	Approved by PAVEL	Date 7/12/2019	Quantity	Material
 <b>MATSING</b> <small>LENS TECHNOLOGY ENABLED</small>						MS-12H90
						MS-12H90 (mm)

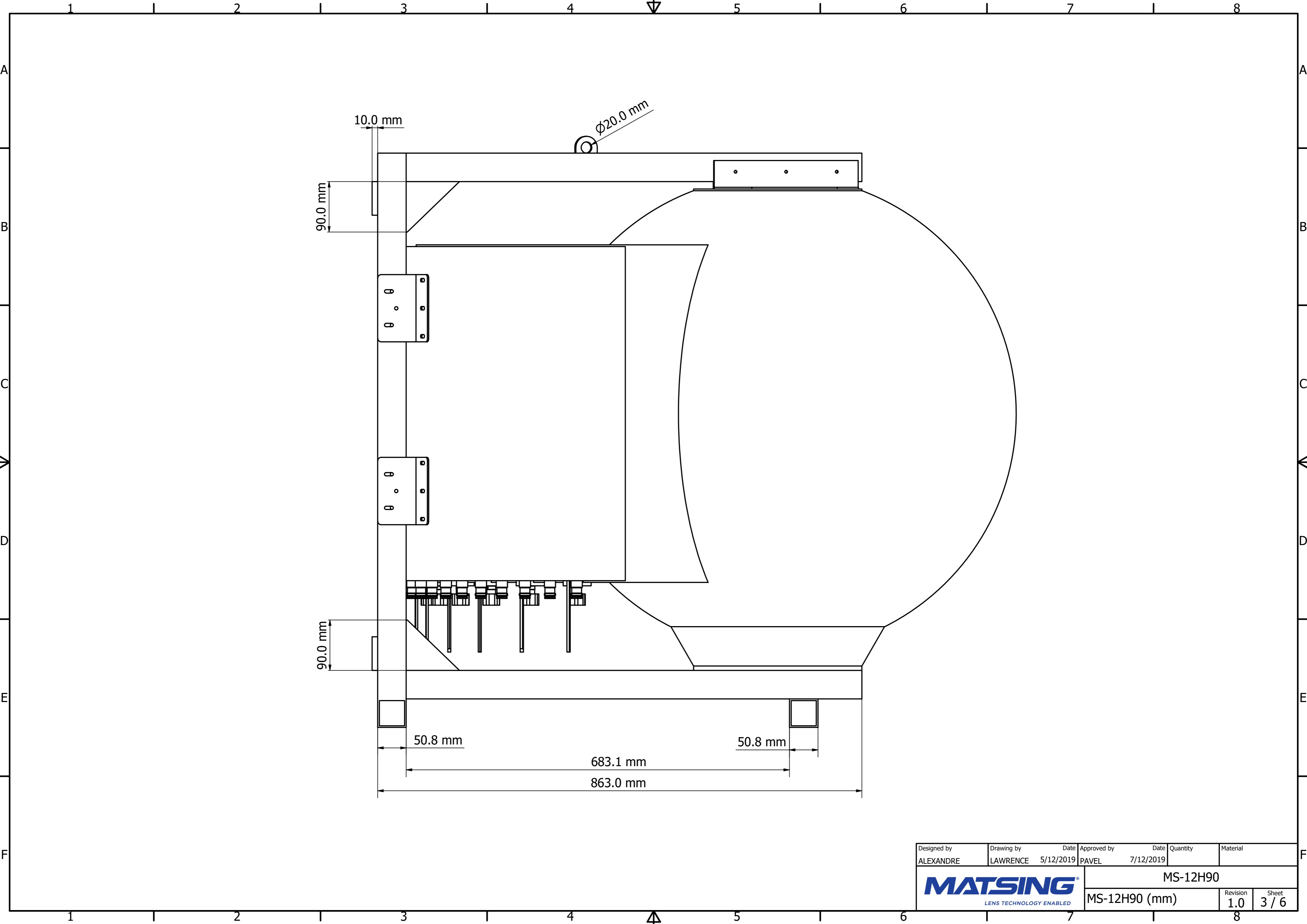

Designed by ALEXANDRE	Drawing by LAWRENCE	Date 5/12/2019	Approved by PAVEL	Date 7/12/2019	Quantity	Material
<b>MATSING</b> LENS TECHNOLOGY ENABLED						MS-12H90
MS-12H90 (mm)					Revision 1.0	Sheet 3 / 6

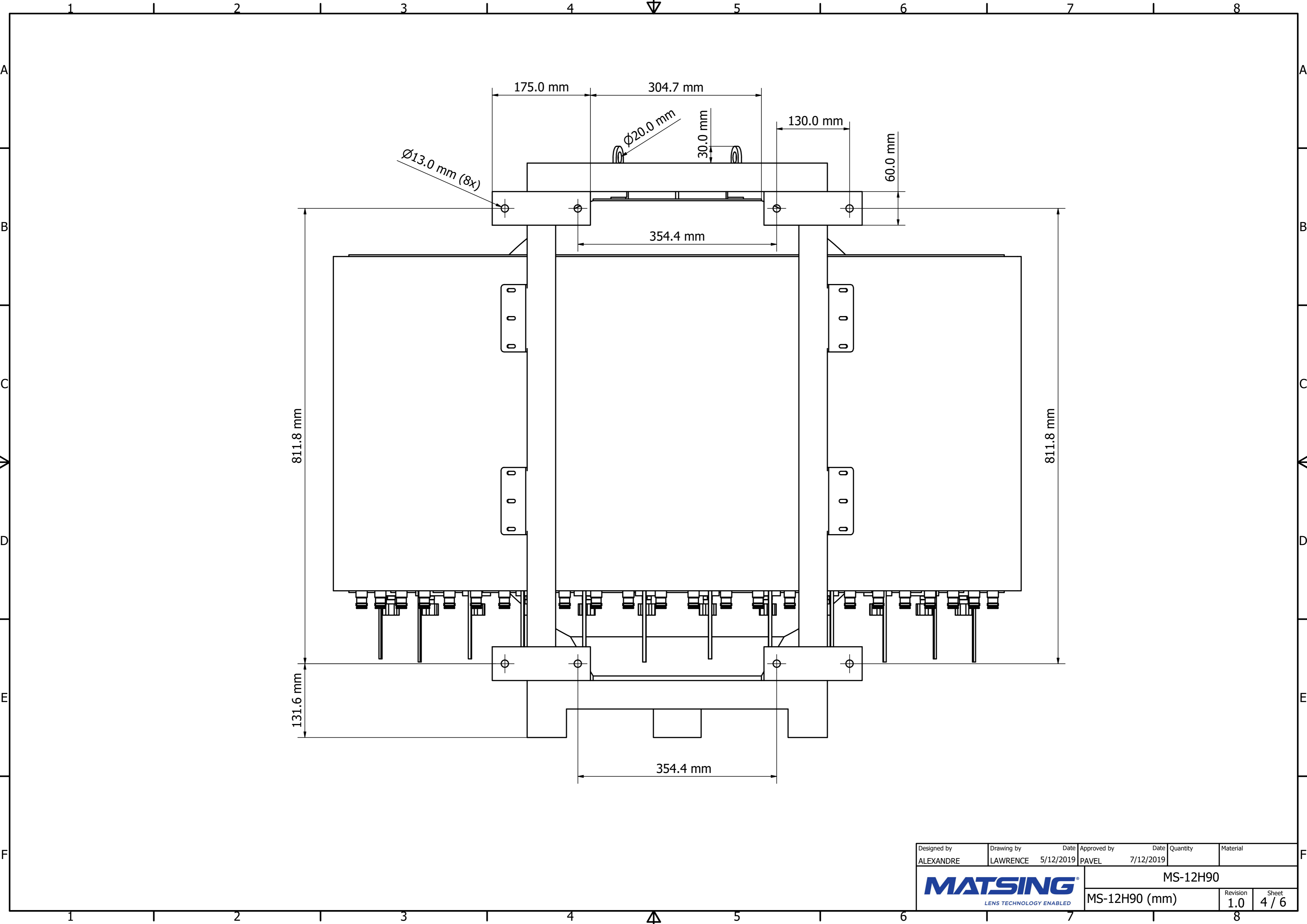

Designed by ALEXANDRE	Drawing by LAWRENCE	Date 5/12/2019	Approved by PAVEL	Date 7/12/2019	Quantity	Material
<b>MATSING</b> LENS TECHNOLOGY ENABLED						MS-12H90
MS-12H90 (mm)					Revision 1.0	Sheet 4 / 6

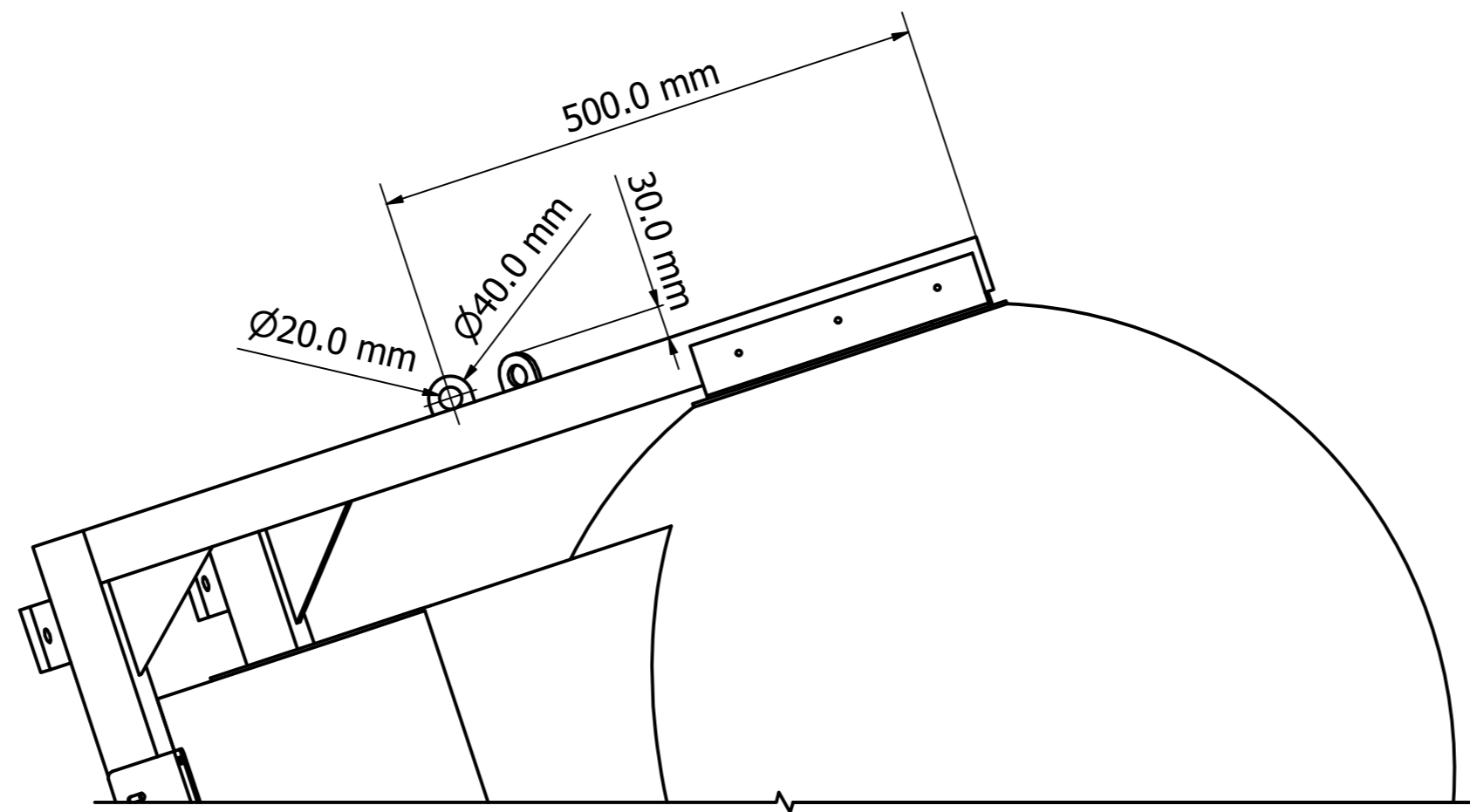

View A

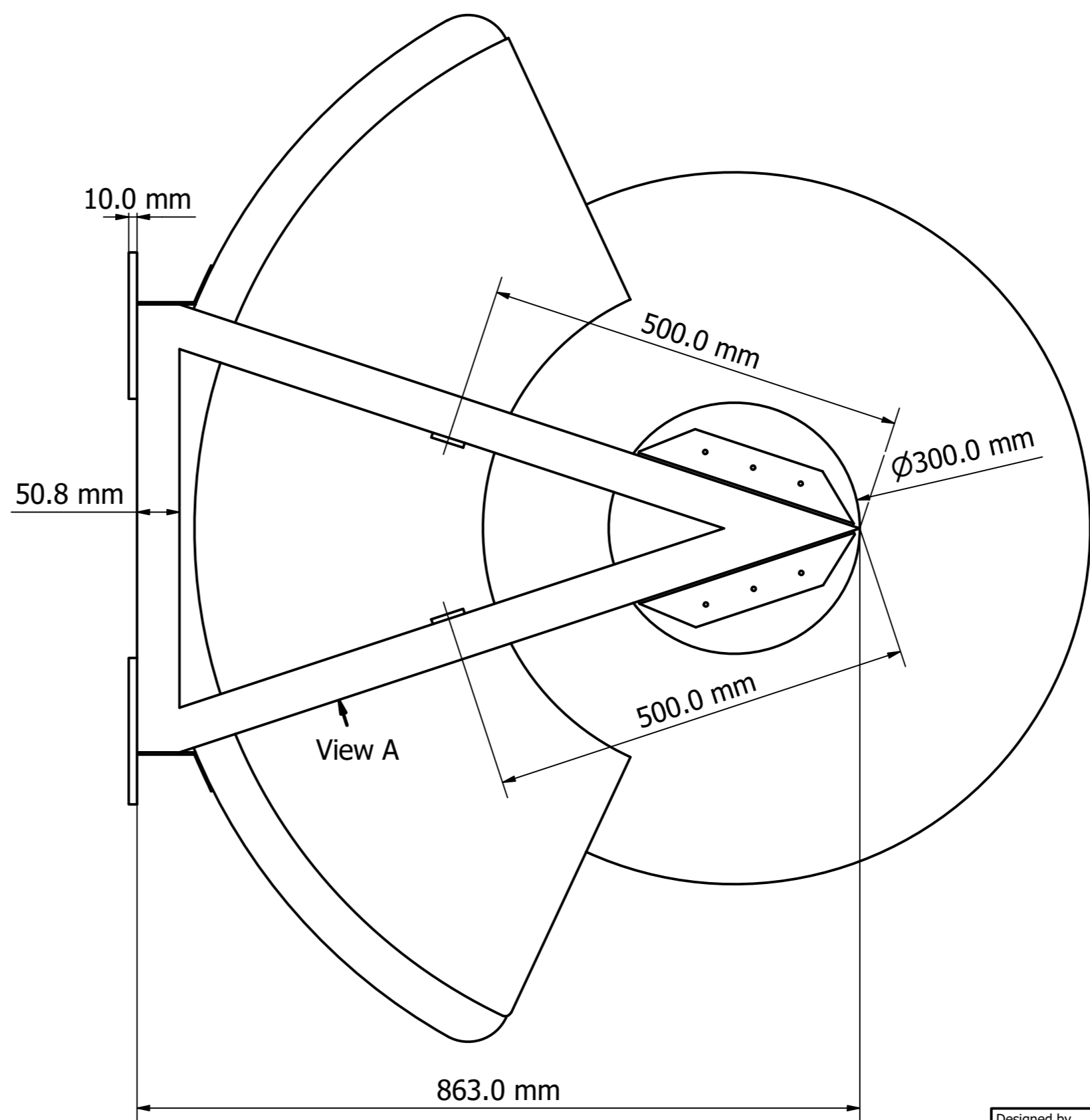

View A

Designed by ALEXANDRE	Drawing by LAWRENCE	Date 5/12/2019	Approved by PAVEL	Date 7/12/2019	Quantity	Material
<b>MATSING</b> LENS TECHNOLOGY ENABLED						MS-12H90
MS-12H90 (mm)					Revision 1.0	Sheet 5 / 6

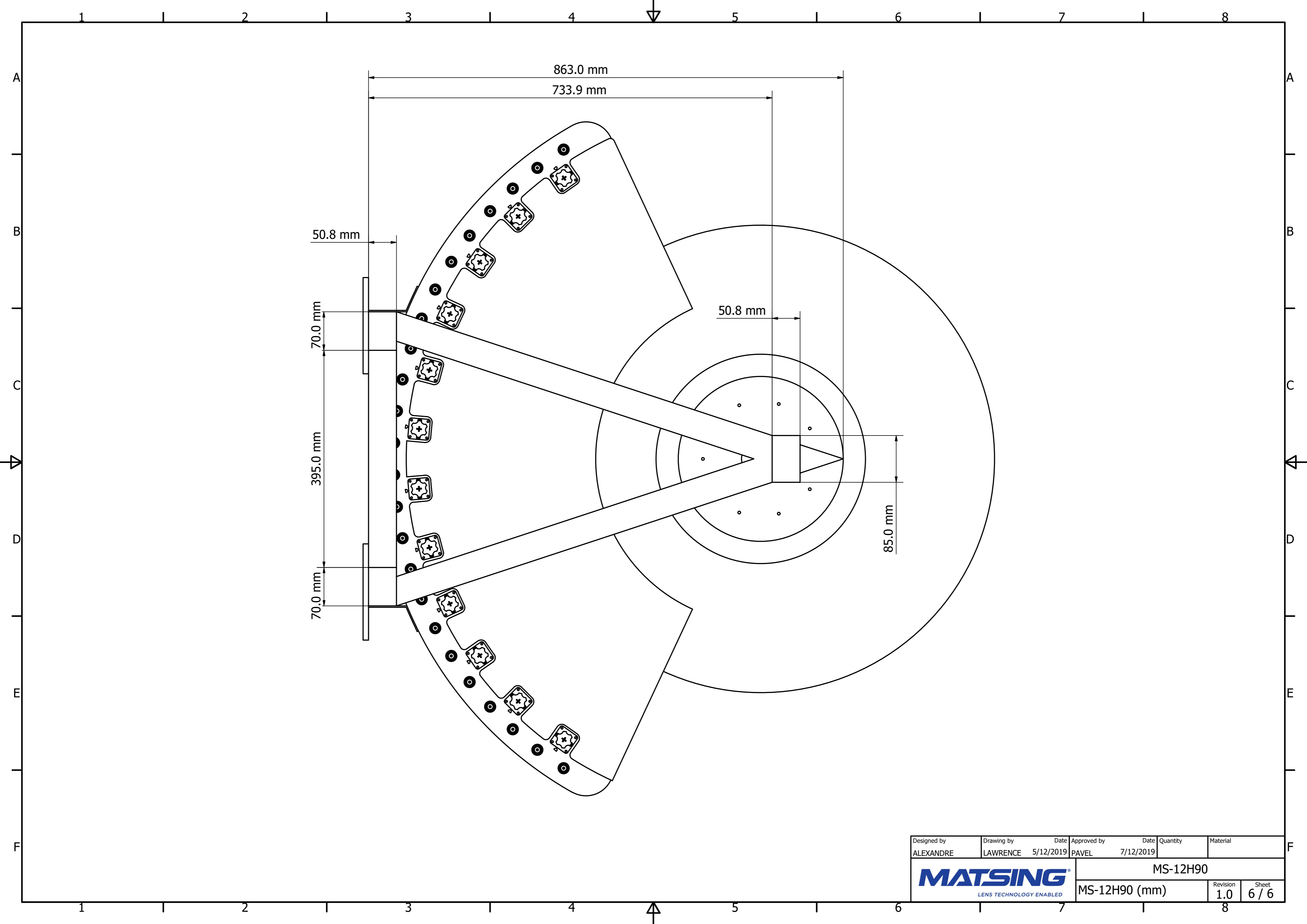

Designed by ALEXANDRE	Drawing by LAWRENCE	Date 5/12/2019	Approved by PAVEL	Date 7/12/2019	Quantity	Material	
<b>MATSING</b> LENS TECHNOLOGY ENABLED						MS-12H90	
MS-12H90 (mm)						Revision 1.0	Sheet 6 / 6