

Designed by ALEXANDRE	Drawing by LAWRENCE	Date 3/12/2019	Approved by PAVEL	Date 3/12/2019	Quantity	Material
<b>MATSING</b> LENS TECHNOLOGY ENABLED						MS-18H90
MS-18H90 (mm)					Revision 1.0	Sheet 1 / 6

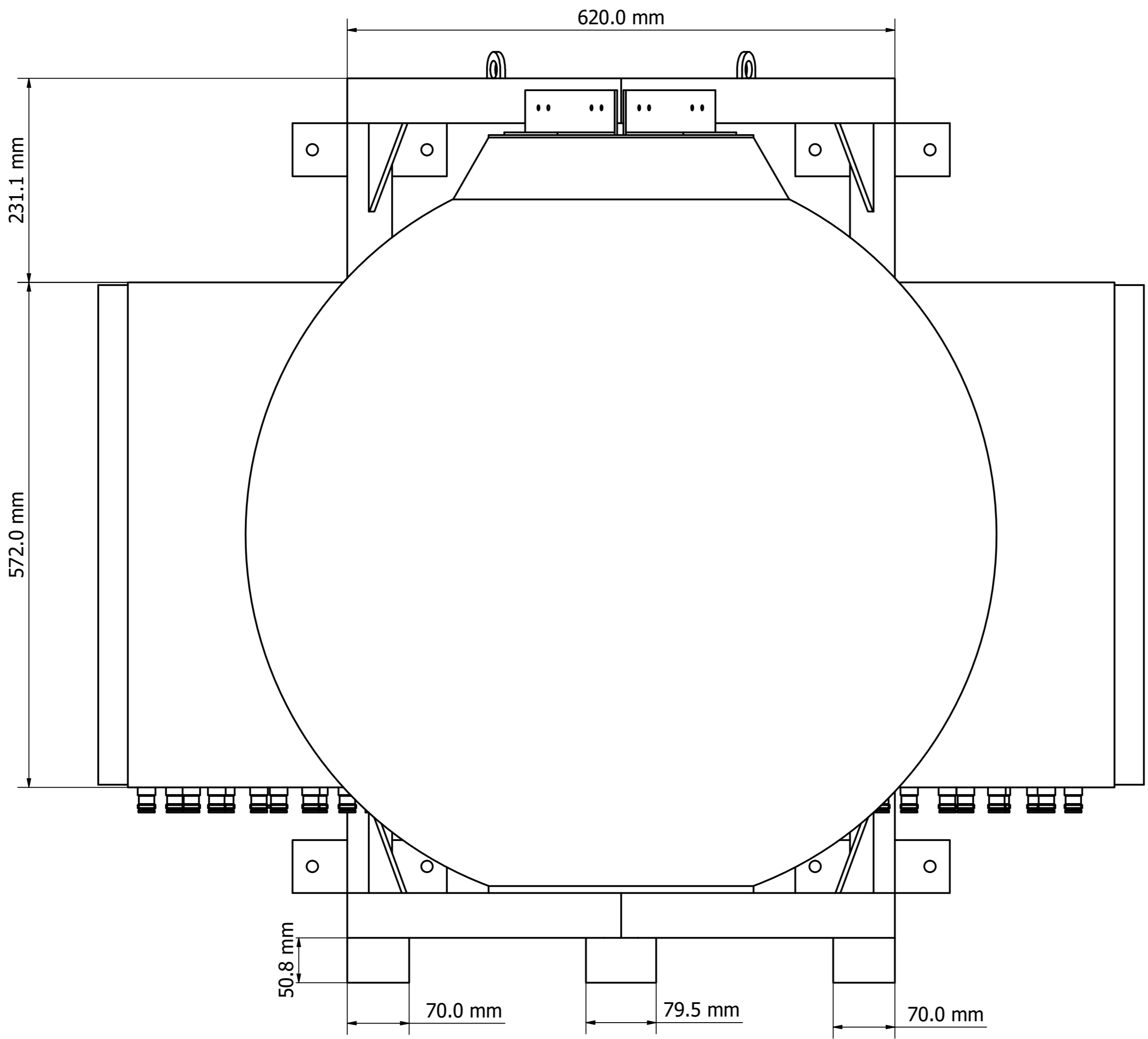

Designed by ALEXANDRE	Drawing by LAWRENCE	Date 3/12/2019	Approved by PAVEL	Date 3/12/2019	Quantity	Material
						MS-18H90
						MS-18H90 (mm)

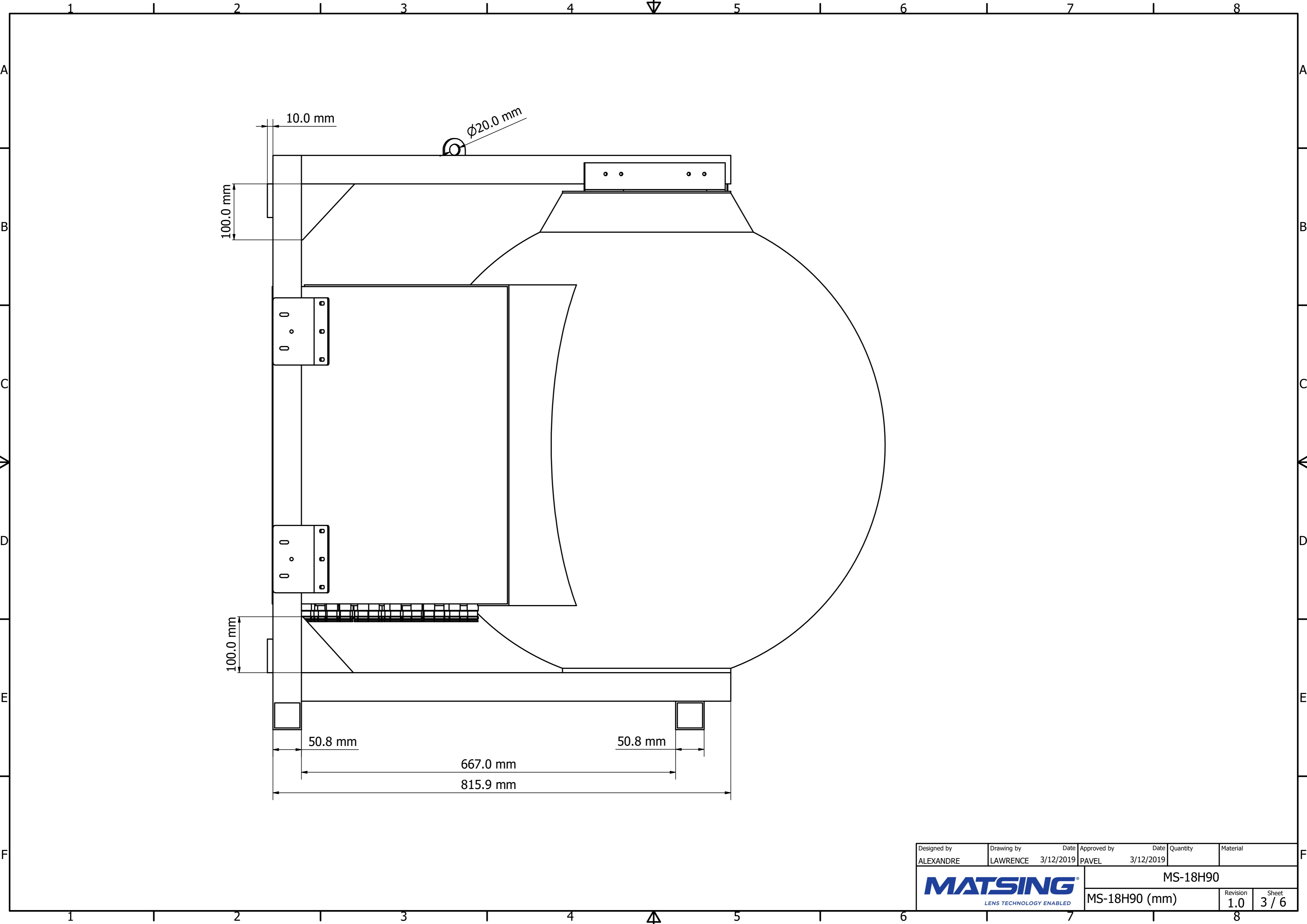

Designed by ALEXANDRE	Drawing by LAWRENCE	Date 3/12/2019	Approved by PAVEL	Date 3/12/2019	Quantity	Material
<b>MATSING</b> LENS TECHNOLOGY ENABLED						MS-18H90
MS-18H90 (mm)					Revision 1.0	Sheet 3 / 6

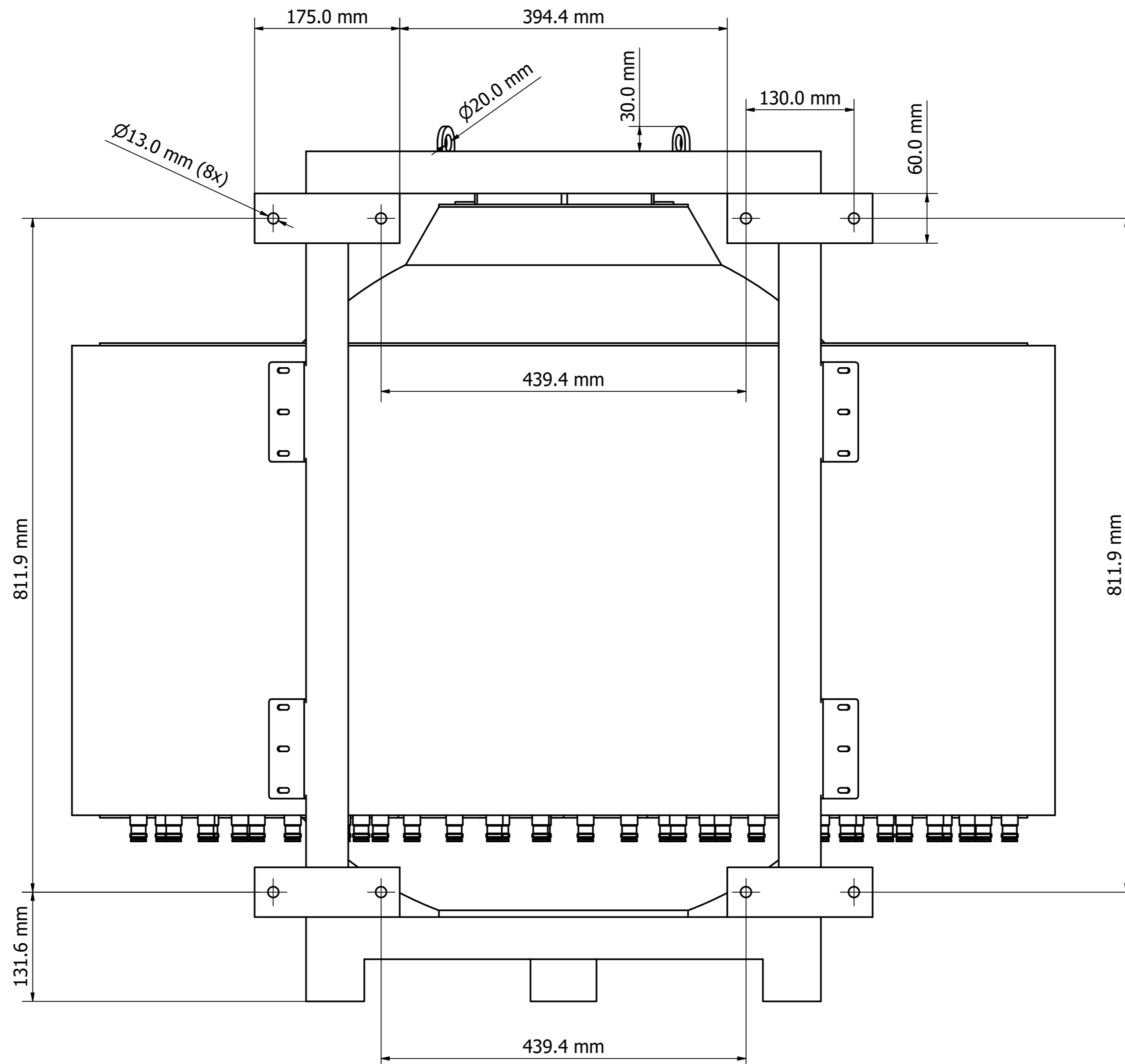

Designed by ALEXANDRE	Drawing by LAWRENCE	Date 3/12/2019	Approved by PAVEL	Date 3/12/2019	Quantity	Material
<b>MATSING</b> LENS TECHNOLOGY ENABLED						MS-18H90
MS-18H90 (mm)					Revision 1.0	Sheet 4 / 6

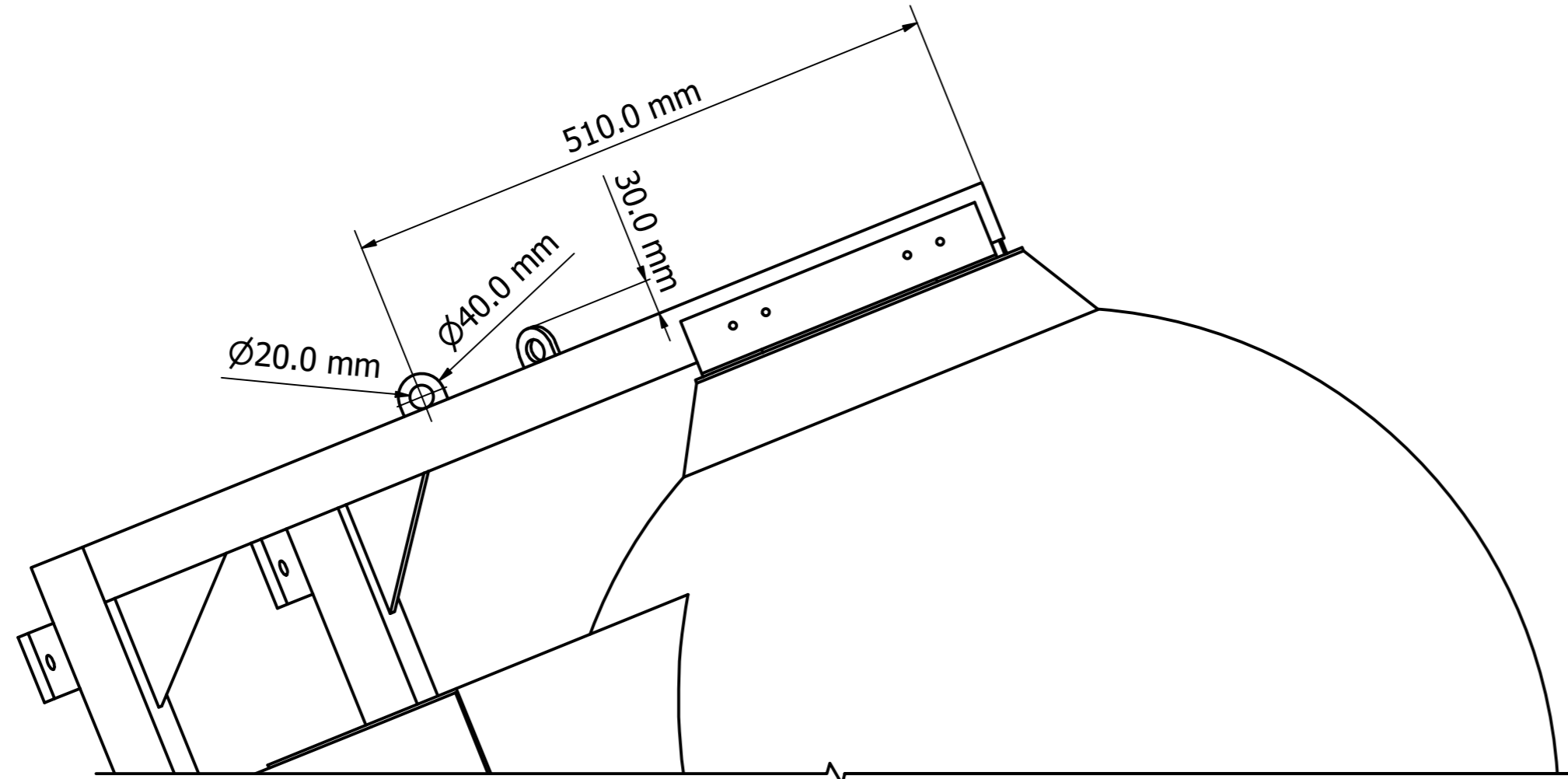

View A

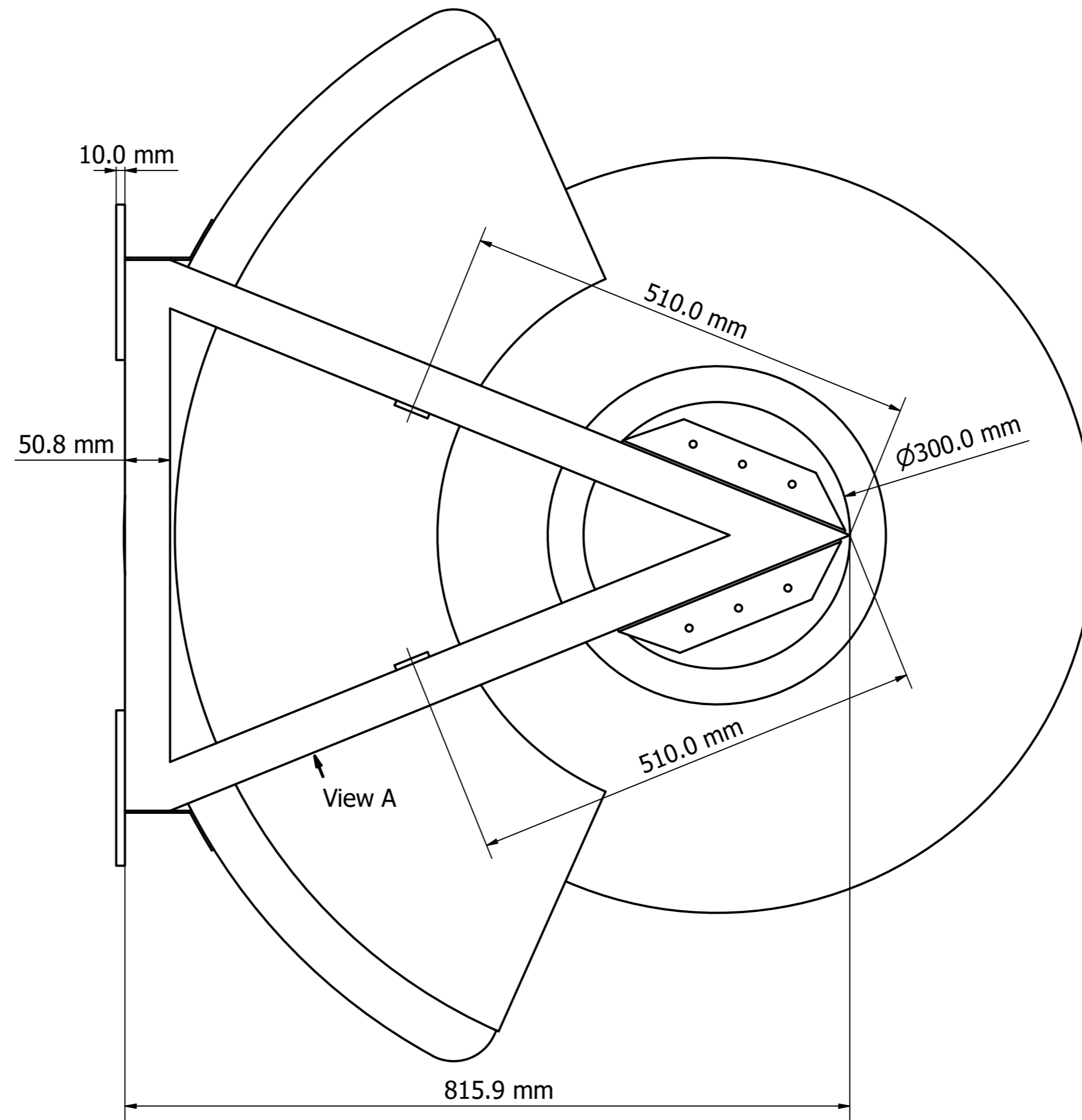

Designed by ALEXANDRE	Drawing by LAWRENCE	Date 3/12/2019	Approved by PAVEL	Date 3/12/2019	Quantity	Material
<b>MATSING</b> LENS TECHNOLOGY ENABLED						MS-18H90
MS-18H90 (mm)					Revision 1.0	Sheet 5 / 6

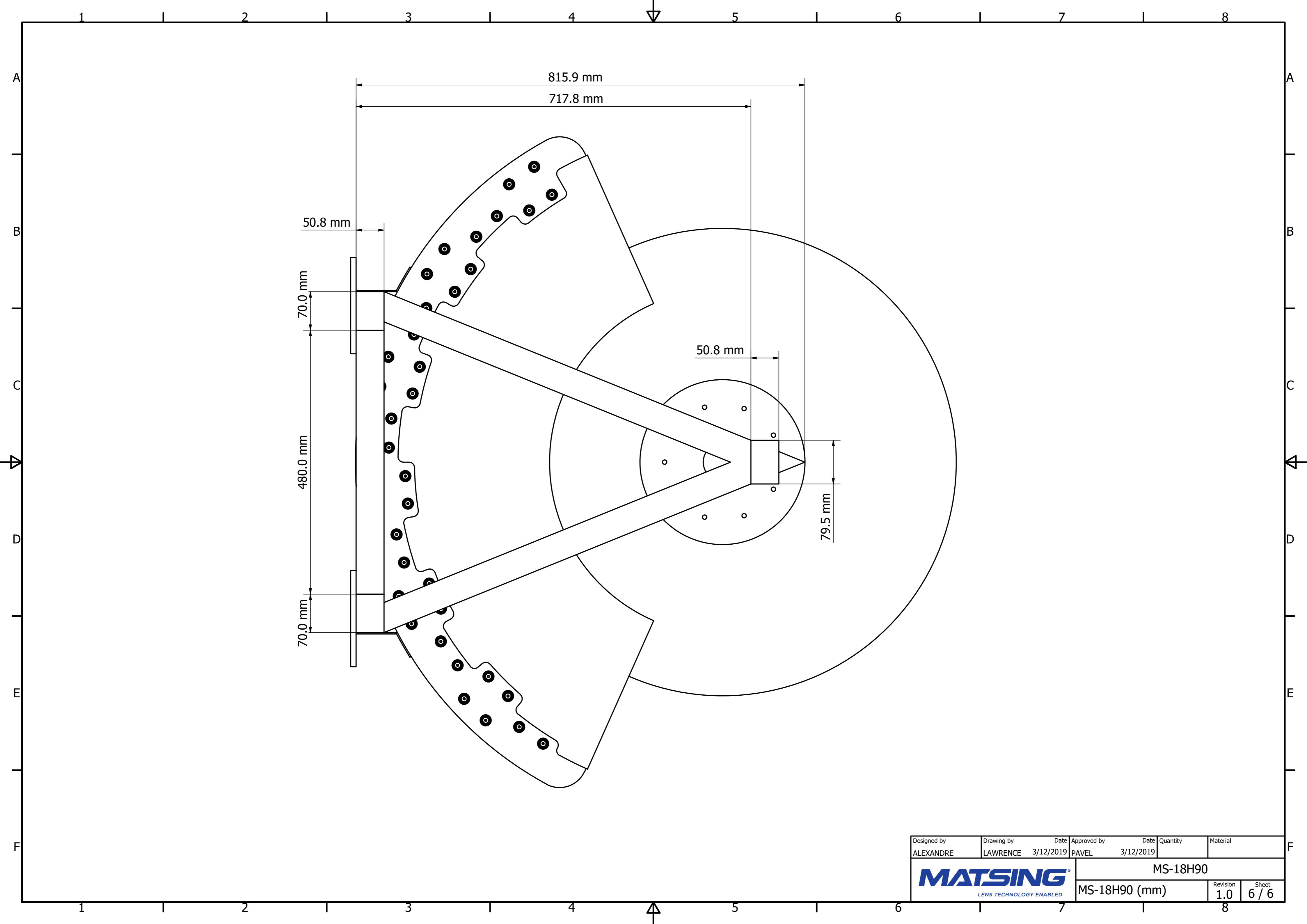

Designed by ALEXANDRE	Drawing by LAWRENCE	Date 3/12/2019	Approved by PAVEL	Date 3/12/2019	Quantity	Material
						MS-18H90
						MS-18H90 (mm)