

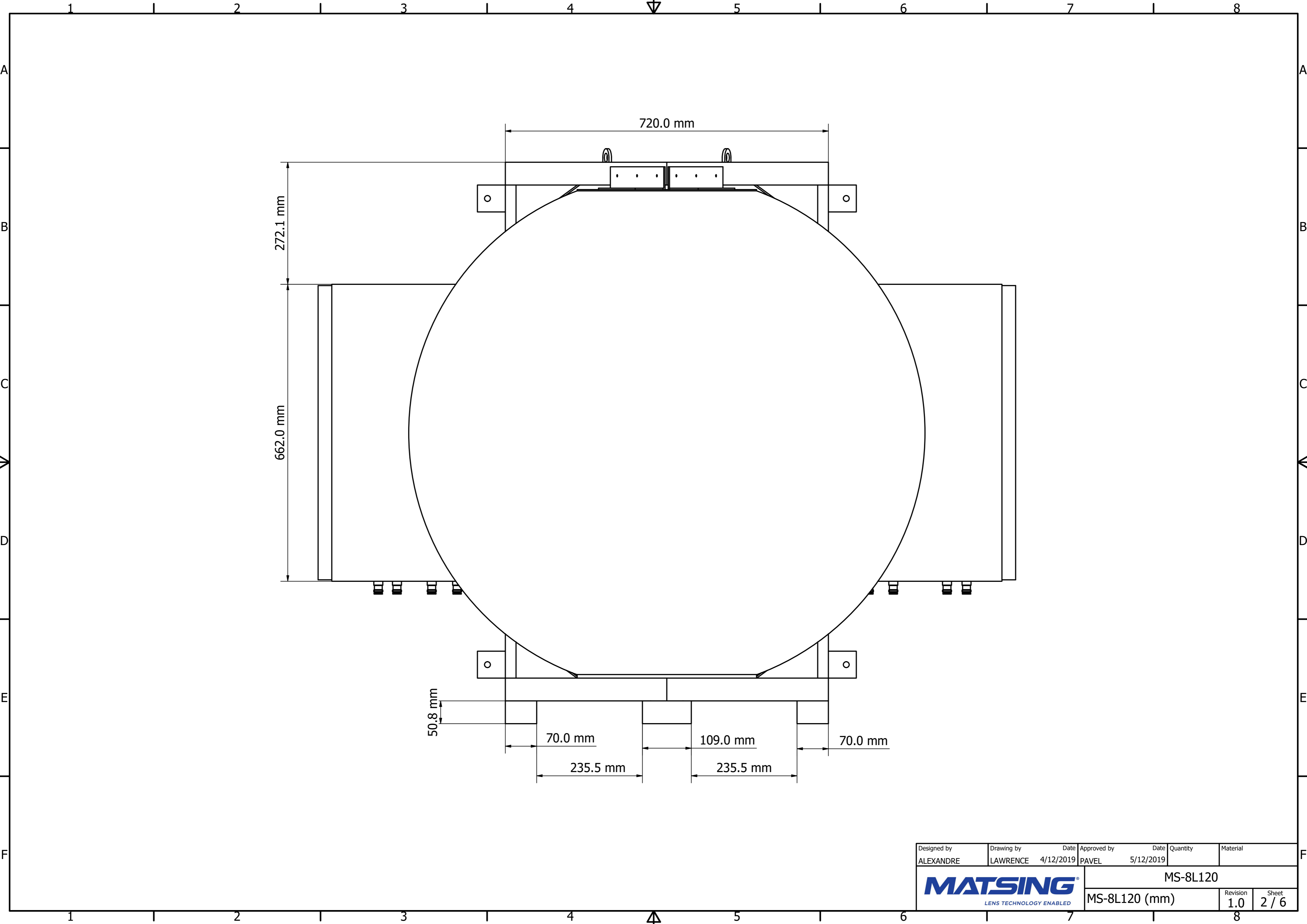

Designed by ALEXANDRE	Drawing by LAWRENCE	Date 4/12/2019	Approved by PAVEL	Date 5/12/2019	Quantity	Material
<b>MATSING</b> LENS TECHNOLOGY ENABLED						MS-8L120
MS-8L120 (mm)					Revision 1.0	Sheet 1 / 6



Designed by ALEXANDRE	Drawing by LAWRENCE	Date 4/12/2019	Approved by PAVEL	Date 5/12/2019	Quantity	Material
						MS-8L120
						MS-8L120 (mm)

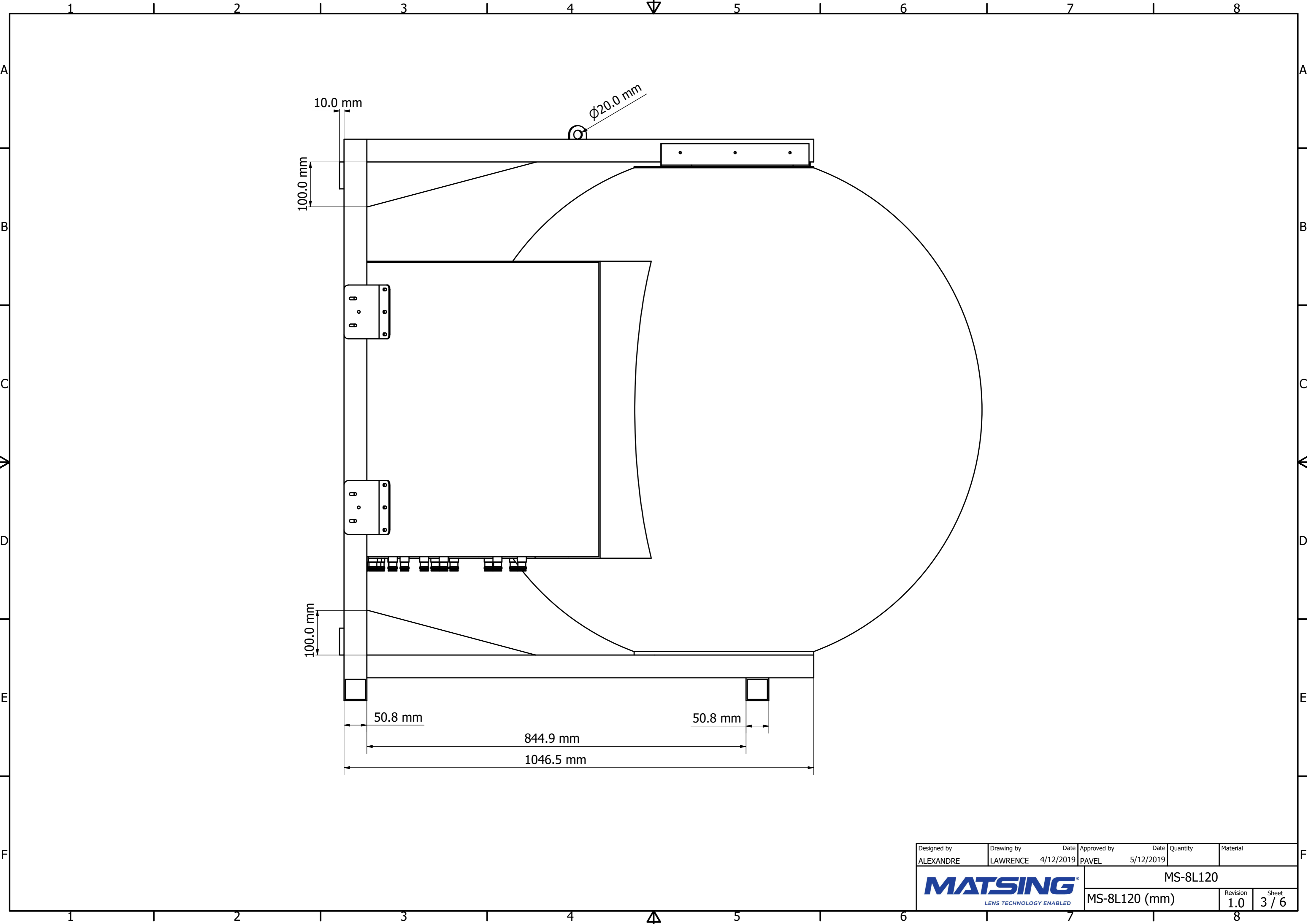

Designed by ALEXANDRE	Drawing by LAWRENCE	Date 4/12/2019	Approved by PAVEL	Date 5/12/2019	Quantity	Material
<b>MATSING</b> LENS TECHNOLOGY ENABLED						MS-8L120
MS-8L120 (mm)					Revision 1.0	Sheet 3 / 6

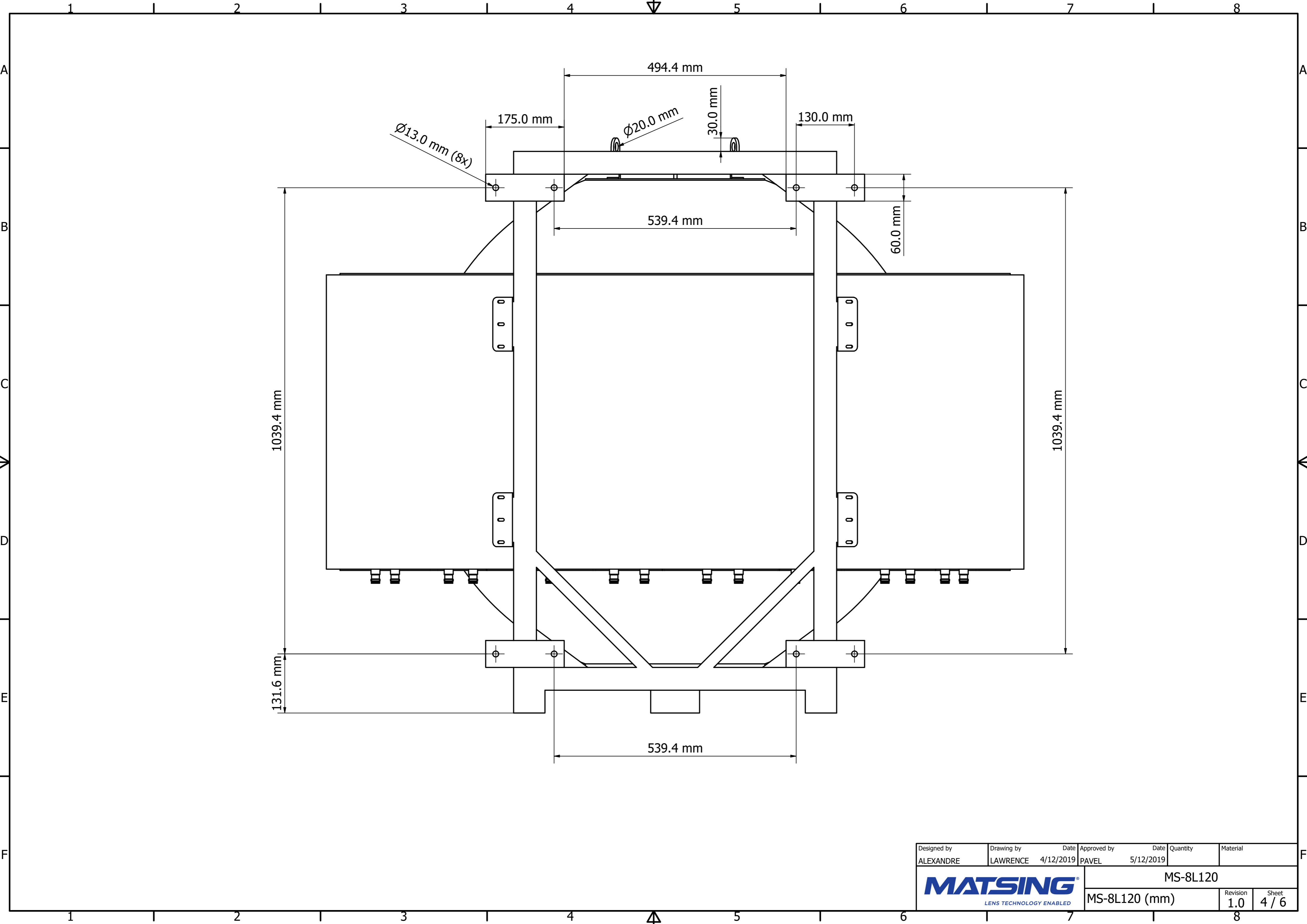

Designed by ALEXANDRE	Drawing by LAWRENCE	Date 4/12/2019	Approved by PAVEL	Date 5/12/2019	Quantity	Material
 <b>MATSING</b> <small>LENS TECHNOLOGY ENABLED</small>						MS-8L120
						MS-8L120 (mm)

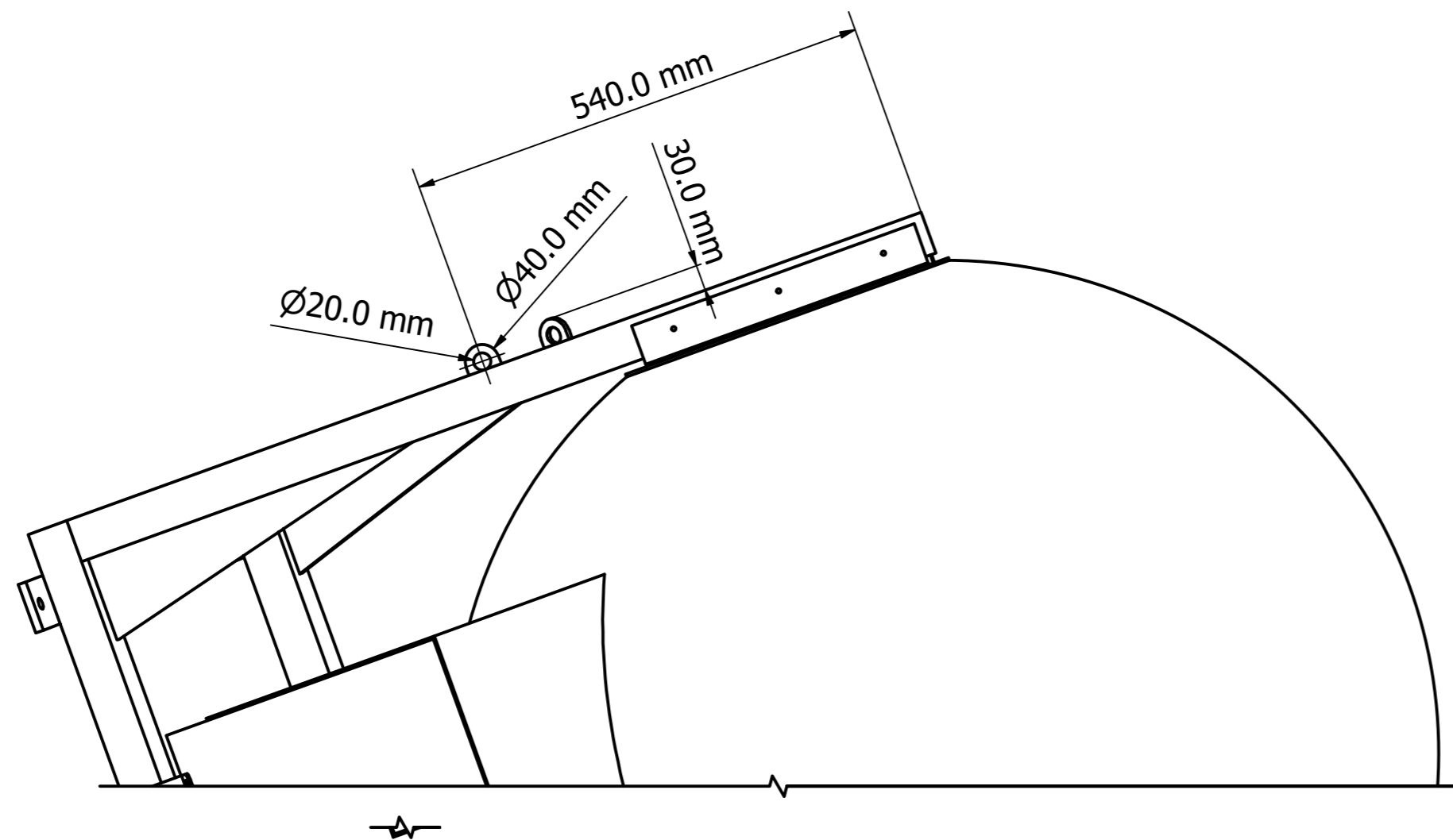

View A

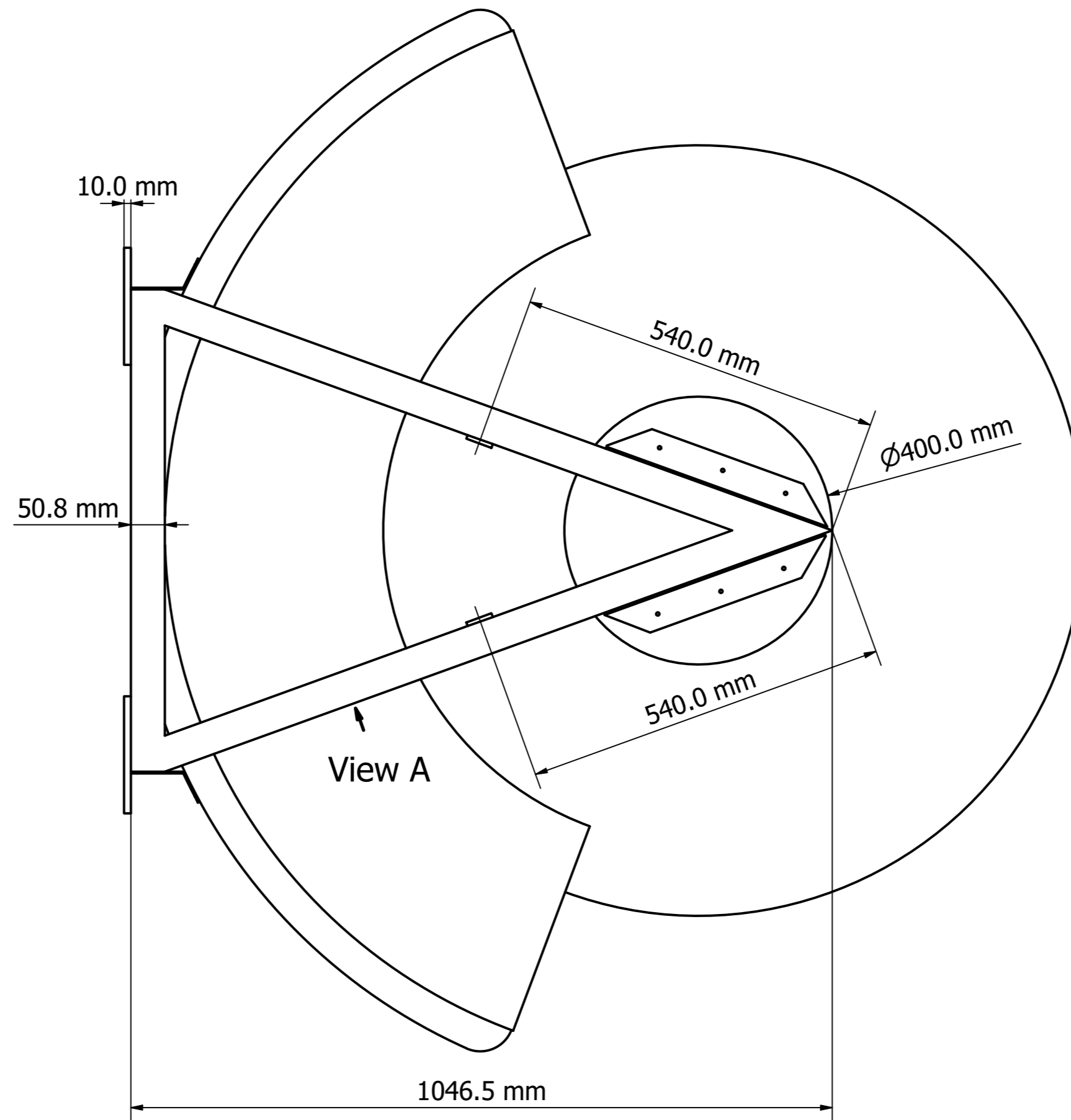

View A

Designed by ALEXANDRE	Drawing by LAWRENCE	Date 4/12/2019	Approved by PAVEL	Date 5/12/2019	Quantity	Material
<b>MATSING</b> LENS TECHNOLOGY ENABLED						MS-8L120
MS-8L120 (mm)					Revision 1.0	Sheet 5 / 6

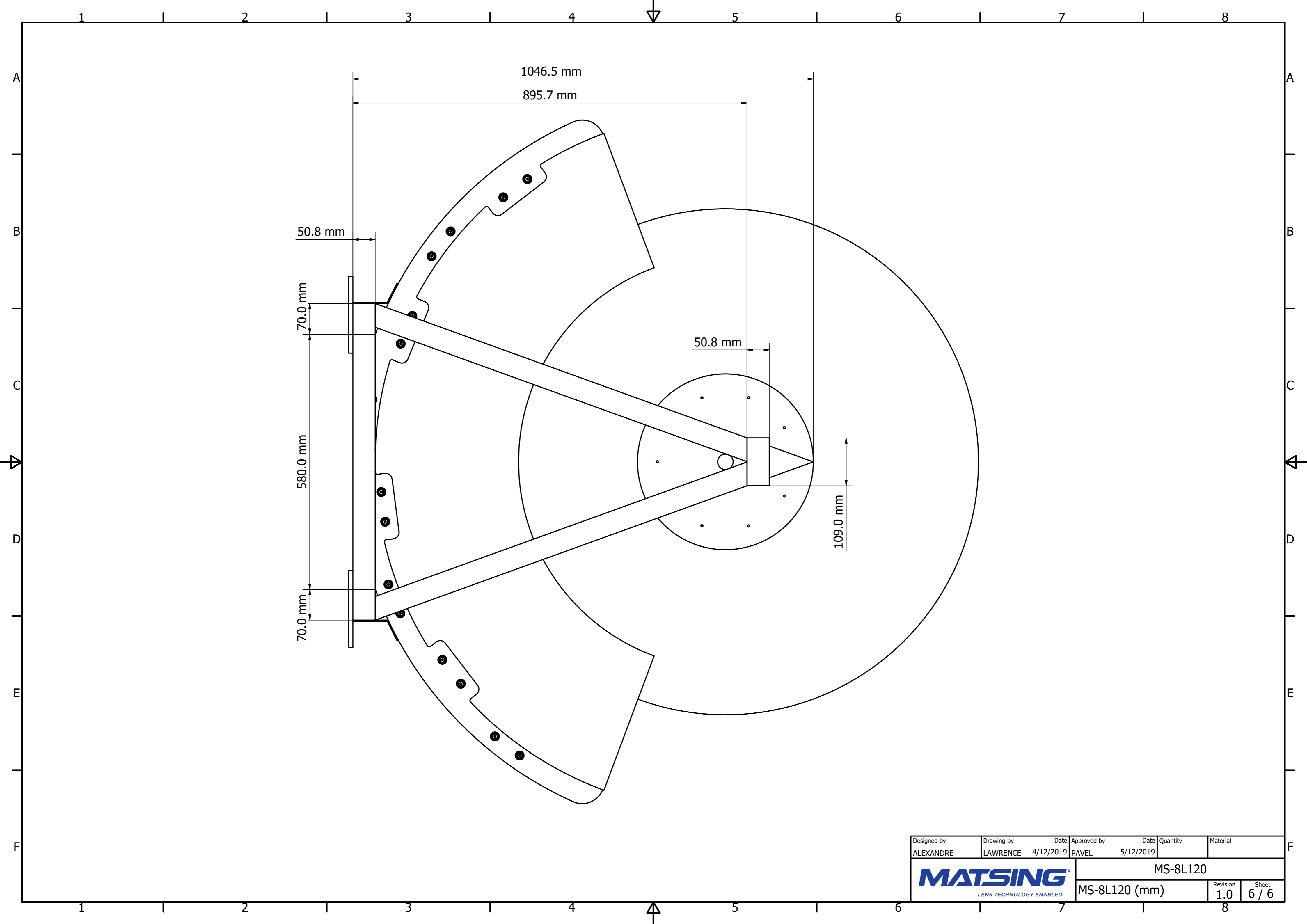

Designed by ALEXANDRE	Drawing by LAWRENCE	Date 4/12/2019	Approved by PAVEL	Date 5/12/2019	Quantity	Material
<b>MATSING</b> LENS TECHNOLOGY ENABLED						MS-8L120
MS-8L120 (mm)					Revision 1.0	Sheet 6 / 6