

MS-MBA-4-H4

Multi-Beam High Band Spherical Lens Antenna capable of four independent high-frequency (1695-2690MHz) cross-polarized beams to support 4X4 MIMO. Each beam has independent tilt adjust from 0° to 20°.

MS-MBA-4-H4 has standard RET capability.

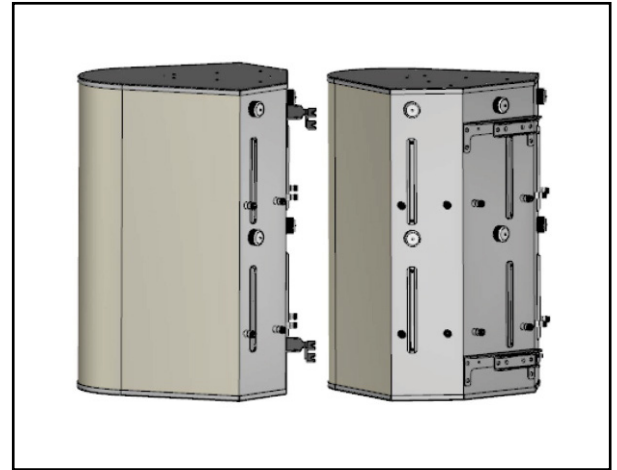

PATTERN RESULTS:

High-band Horizontal Pattern (1.92GHz)

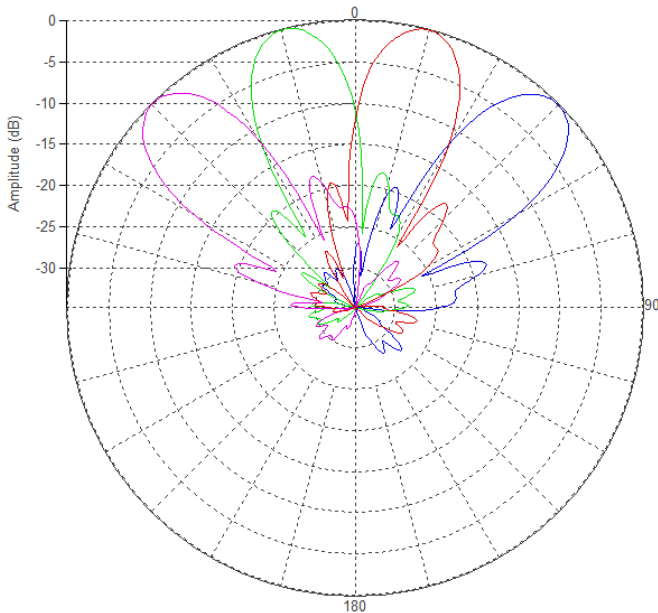

High-band Vertical Pattern (1.92GHz) at tilt 0° and 20°

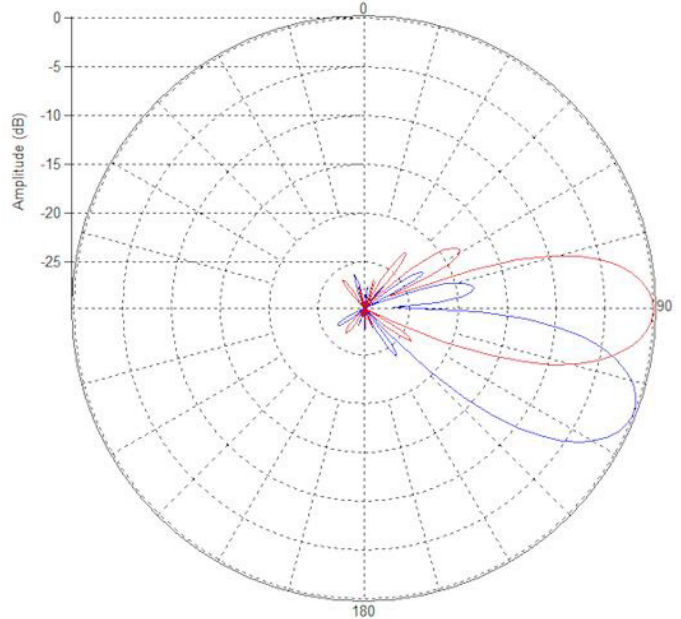

TECHNICAL SPECIFICATIONS

Frequency	1695-2690 MHz
Gain	19dBi
VSWR	<1.5:1
Polarization	Dual Slant ±45°
Horizontal Coverage	120°
Horizontal Beamwidth (10dB level)	30°
Horizontal Beamwidth (3dB level)	17°
Vertical Beamwidth (10dB level)	30°
Vertical Beamwidth (3dB level)	17°
Beam Cross-over	10dB typical
Total Number of Beams	4
Number of Ports per Beam	4
Number of Ports Total	16
Tilt Per Cross-Pol (Four adjustments per beam) Remote Electrical Tilt (AISG 2.0)	0° to 20°
First Sidelobe level	<-16dB
Front to Back Ratio	>28dB
Isolation Port to Port - Polarization	>28dB
Isolation Port to Port - Beam	>26dB
Power Rating	200W per port
Intermodulation	<-153dBc
Impedance	50 ohm
Connector Quantity and Type	8 x 4.3-10 female

MECHANICAL DATA

Dimensions (H x W x D)	110 x 61 x 66cm 43 x 24 x 26 inch
Antenna Weight	35kg 77lbs
Radome Material	Fiber Glass
Mounting	2 position pipe mount Compatible pipe diameter: 6.1 – 11.4 cm 2.4 – 4.5 inch

ENVIRONMENTAL RATINGS

Humidity	95% RH @ +30°C
Temperature	-40°C to +70°C
Wind load (Front)	462 N @ 151km/hr 104lbf @ 151km/hr