

Date	Prepared by	Approved by	Document nos	Rev
7 Apr 2021	Ray Ling	Pavel	MS-MBA-3-H4-IM-001	1

**INSTRUCTION MANUAL MS-MBA-3-H4 (MBA-4)**

**TABLE OF CONTENTS:**

**1.00 BEAMS & CONNECTORS:**

- 1.10 Plan View Resultant Beam Layout
- 1.20 Connector Ports Table
- 1.30 Connector Detail
- 1.40 Connector Layout

**2.00 PATTERN DIAGRAM**

- 2.10 Frequency: 1695 - 2690 MHz
  - 2.11 Horizontal Pattern
  - 2.12 Vertical Pattern

**3.00 MANUAL TILT ADJUSTMENT**

**4.00 BRACKET INSTALLATION**

- 4.10 Bolts & Nuts Requirements
  - 4.11 Bolts & Nuts
  - 4.12 Bracket
- 4.20 Tools Requirement
  - 4.21 Adjustable Spanner
  - 4.22 M12 Spanner
- 4.30 Bracket Spacing & Installation Sample

**Revision History:**

Date	Description	Revised by	Revision nos.
07-Apr-21	To include the bracket installation process.	Ray Ling	1

**1.00 BEAMS & CONNECTORS:**

**1.10 Plan View Resultant Beam Layout**

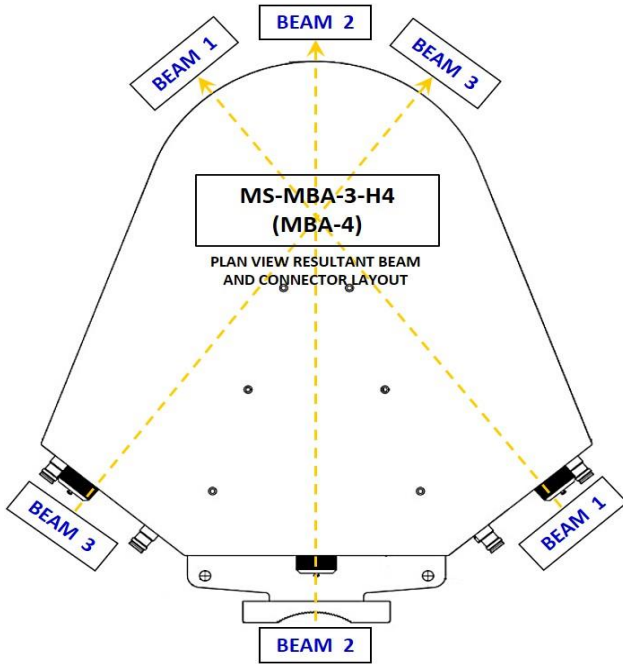

**1.20 Connector Ports Table**

MS-MBA-3-H4 (MBA-4)					
Connector Table					
BEAM 3		BEAM 2		BEAM 1	
Port 11 (+45°)	Port 12 (-45°)	Port 7 (+45°)	Port 8 (-45°)	Port 3 (+45°)	Port 4 (-45°)
Port 9 (+45°)	Port 10 (-45°)	Port 5 (+45°)	Port 6 (-45°)	Port 1 (+45°)	Port 2 (-45°)

**1.40 Connector Layout**

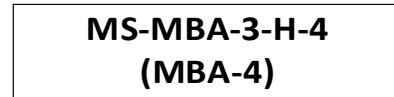

REAR VIEW CONNECTOR LAYOUT

**1.30 Connector Detail**

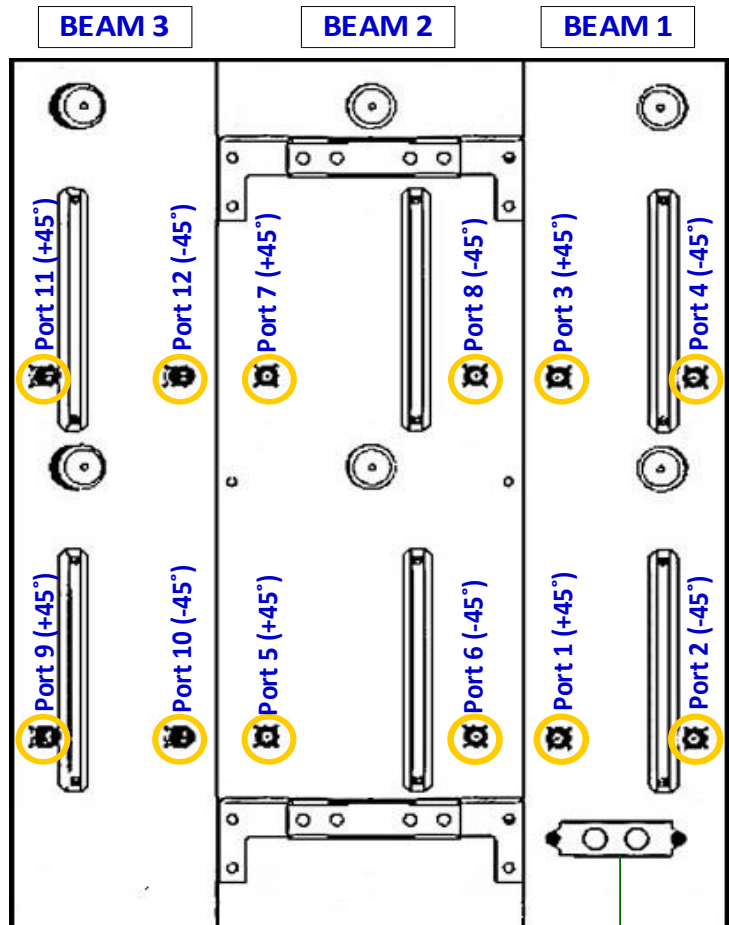
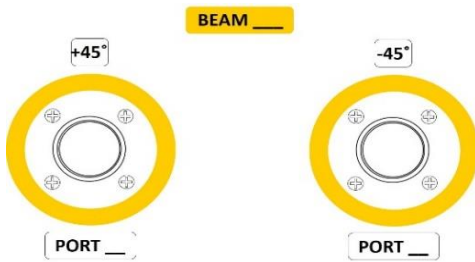

**AISG IN**  
 HB Beams: 1,2,3  
 HB Ports: 1 to 12

**2.00 PATTERN DIAGRAM**

**2.10 Frequency: 1695 - 2690 MHz**

**2.11 Horizontal Pattern**

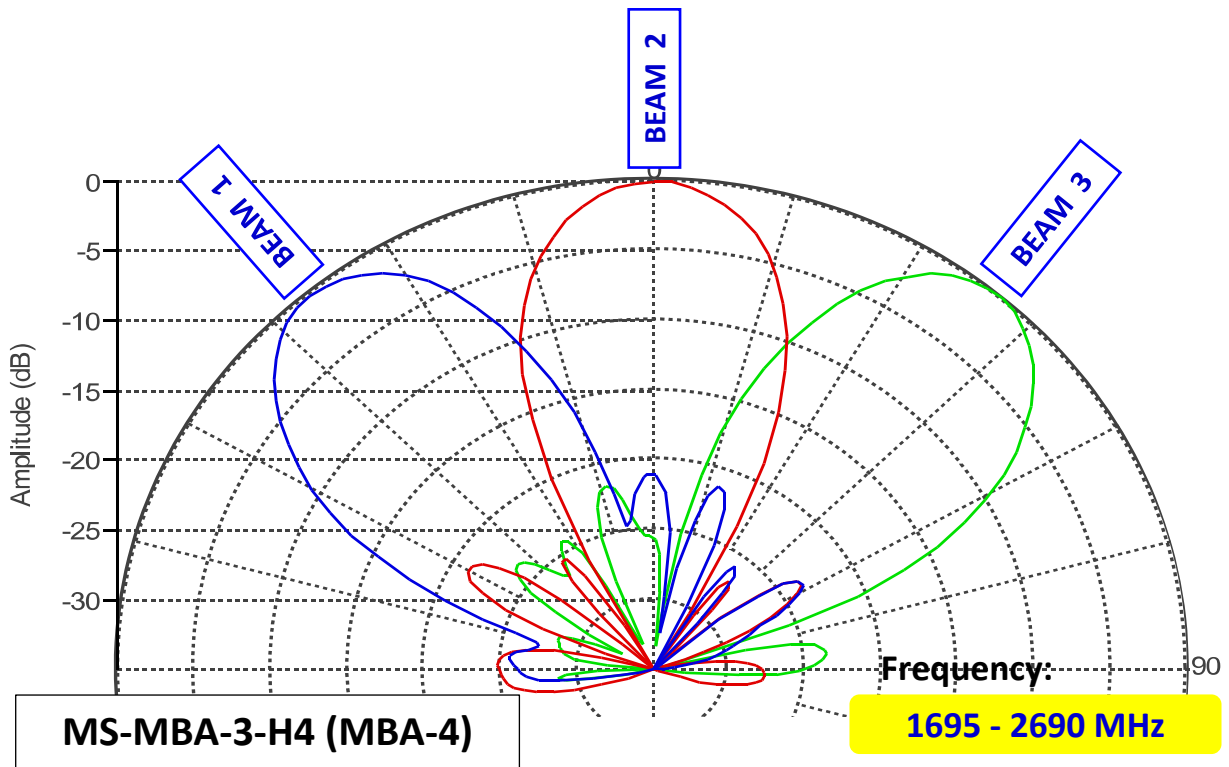

**2.12 Vertical Pattern**

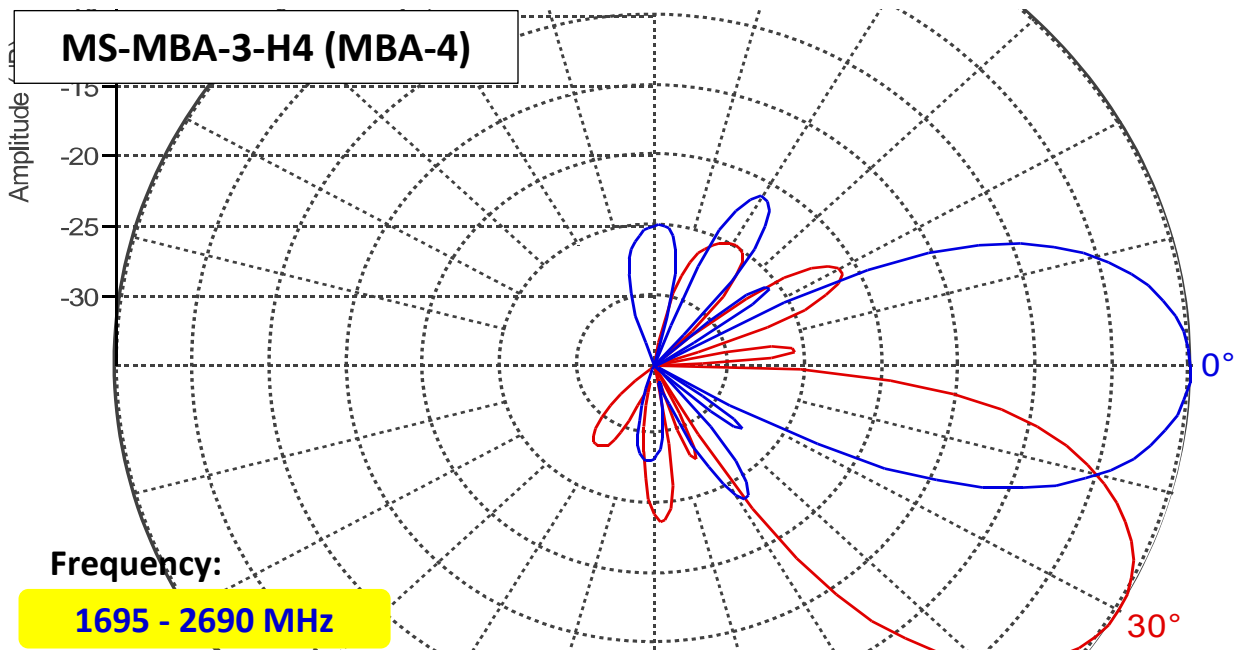

### 3.00 MANUAL TILT ADJUSTMENT

1	The MBA antenna come in RET mode as default, but if needed can also be manually adjusted. To do so, please unscrew the waterproof cap behind the element whose tilt is to be adjusted.
2	By Default the knob is on engaged mode, pull out the handle for manual tilt adjustment, turn the handle to change the tilt.
3	When done, push the handle back in, screw the waterproof cap back to the position.

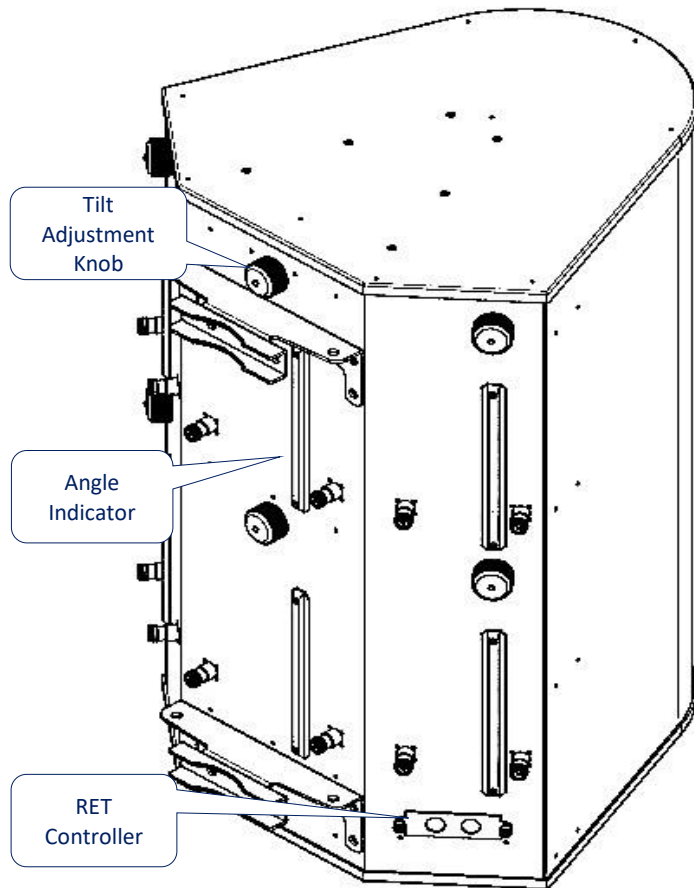

Engaged with internal RET motor position



Unscrew/ Screw the cap for tilt adjustment process



Pull knob out to disengaged RET for tilt adjustment



### 4.00 BRACKET INSTALLATION

#### 4.10 Bolts & Nuts Requirements

nos	Model Apply	Bracket	Bolts		Nuts	
		Qty	Size	Qty	Size	Qty
1	All MBA's Antennas	2	M12 x 200mm	4	M12	10

#### 4.11 Bolts & Nuts



#### 4.12 Bracket



#### 4.20 Tools Requirement

#### 4.21 Adjustable Spanner



#### 4.22 M12 Spanner



#### 4.30 Bracket Spacing & Installation Sample

