

Designed by ALEXANDRE	Drawing by LAWRENCE	Date 10/06/2021	Approved by PAVEL	Date 11/06/2021	Quantity	Material	
MATSING LENS TECHNOLOGY ENABLED						MS-8H60	
MS-8H60 (mm)						Revision 1.5	Sheet 1 / 6

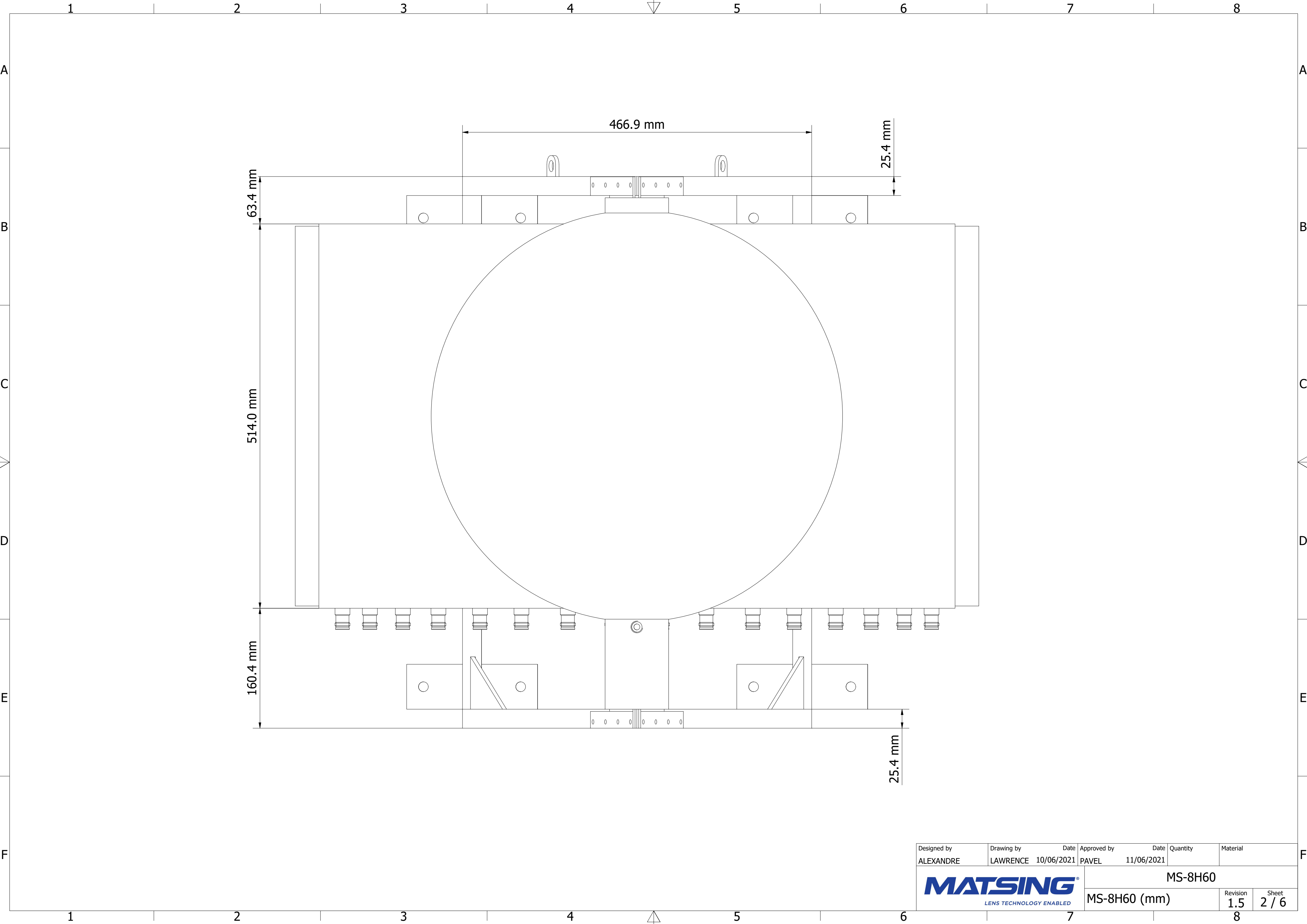

Designed by ALEXANDRE	Drawing by LAWRENCE	Date 10/06/2021	Approved by PAVEL	Date 11/06/2021	Quantity	Material
					MS-8H60	
					MS-8H60 (mm)	Revision 1.5

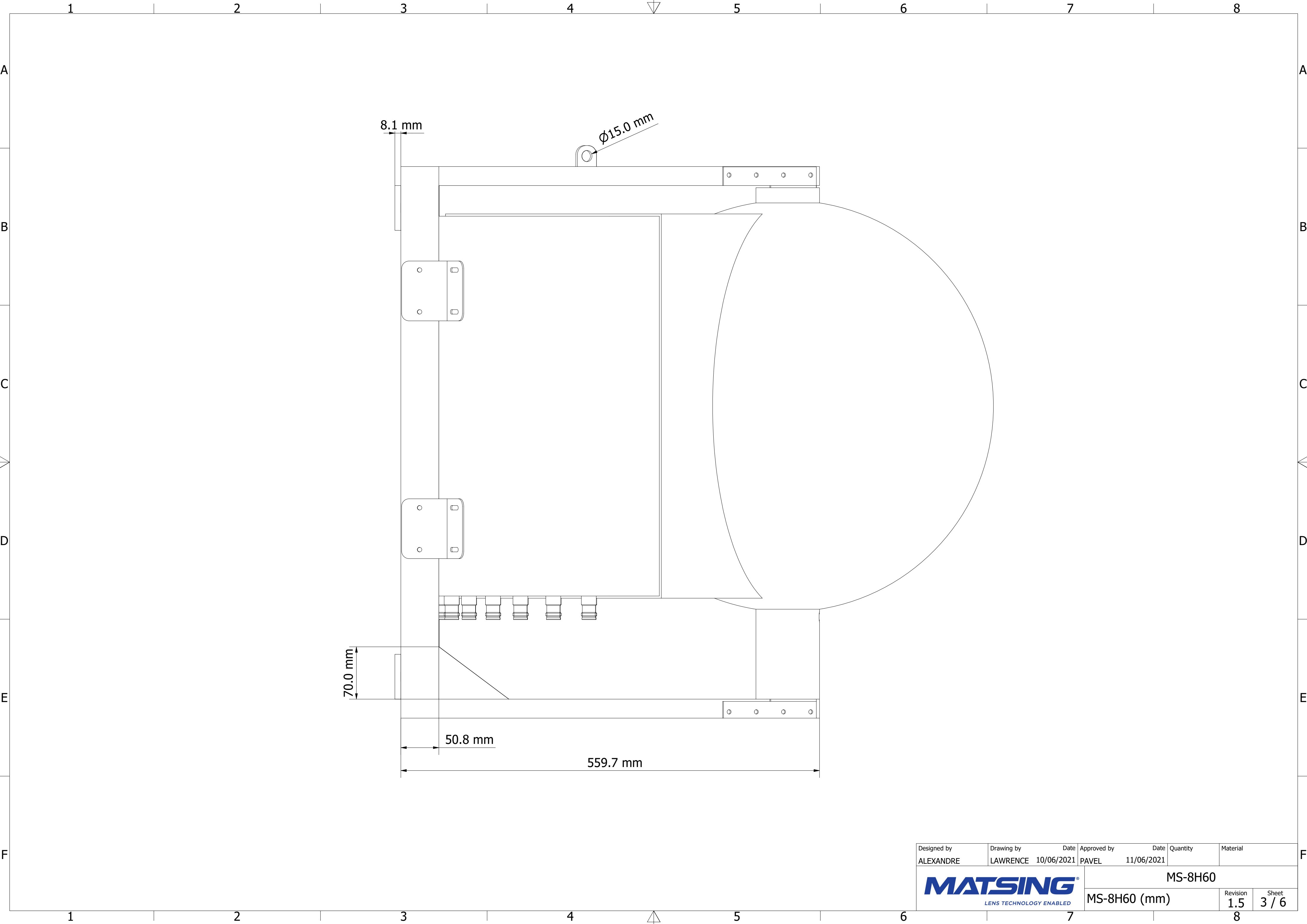

Designed by ALEXANDRE	Drawing by LAWRENCE	Date 10/06/2021	Approved by PAVEL	Date 11/06/2021	Quantity	Material
MATSING LENS TECHNOLOGY ENABLED						MS-8H60
MS-8H60 (mm)					Revision 1.5	Sheet 3 / 6

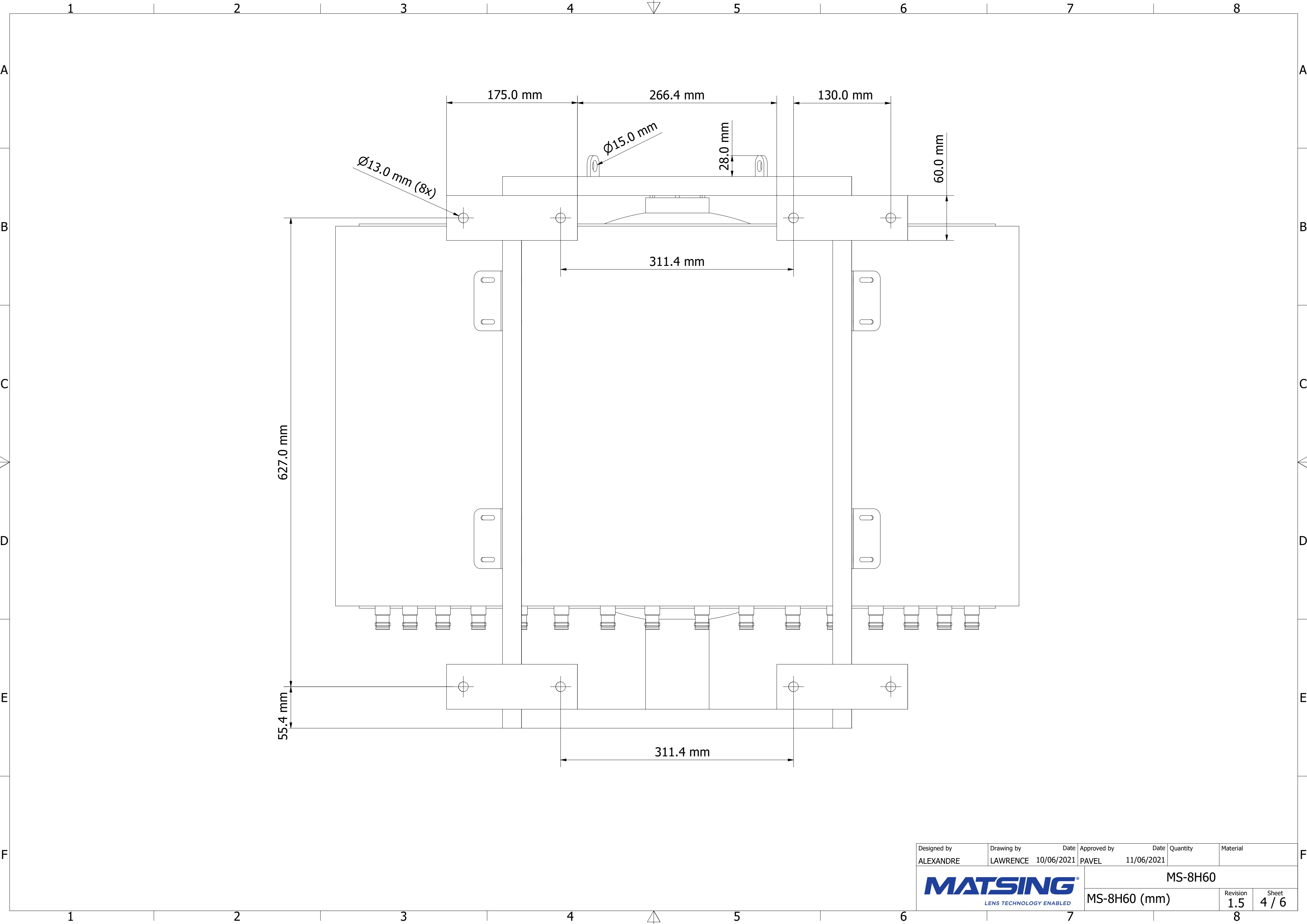

Designed by ALEXANDRE	Drawing by LAWRENCE	Date 10/06/2021	Approved by PAVEL	Date 11/06/2021	Quantity	Material
 MATSING <small>LENS TECHNOLOGY ENABLED</small>			MS-8H60			
			MS-8H60 (mm)			Revision 1.5

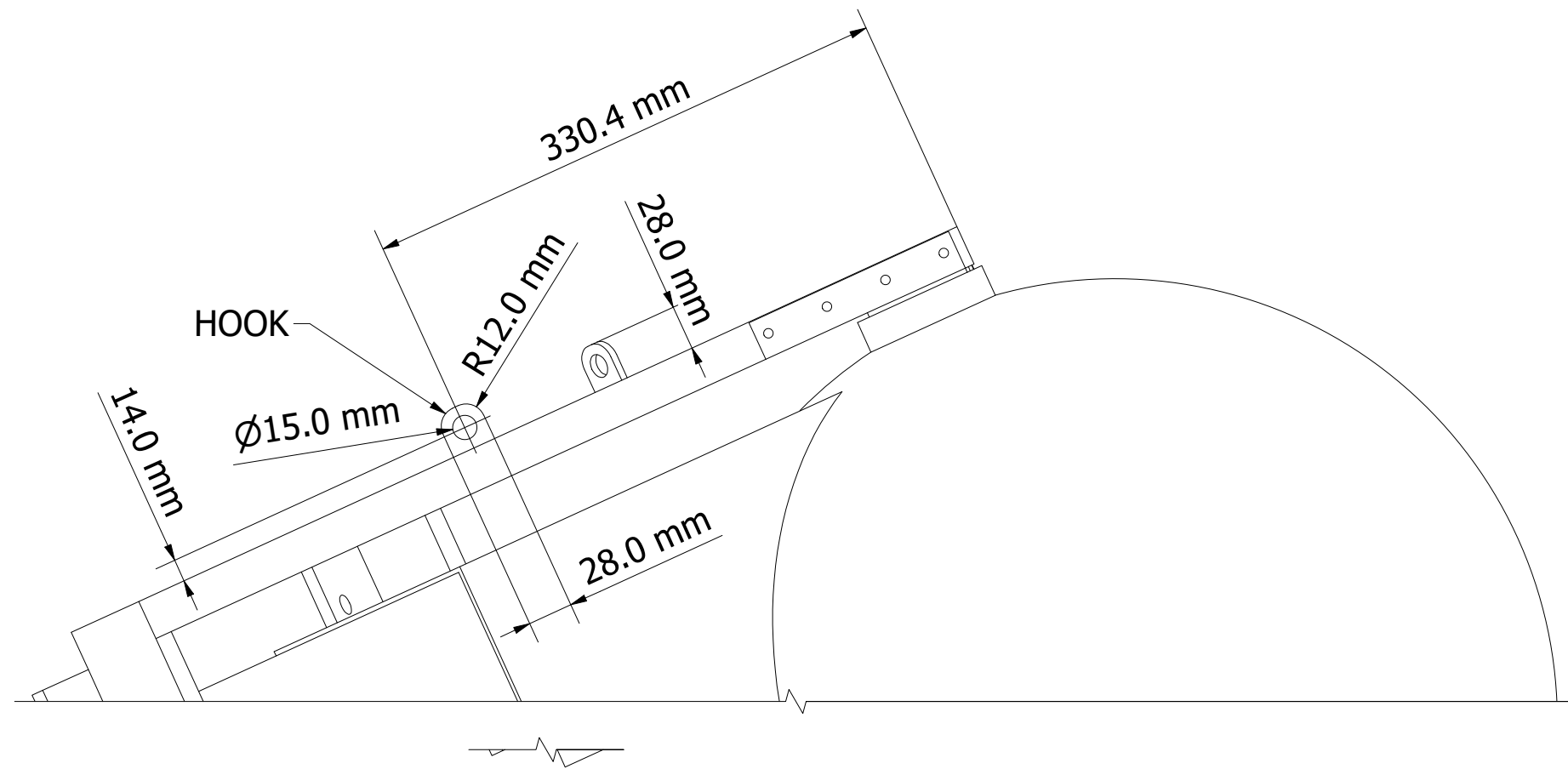

View A

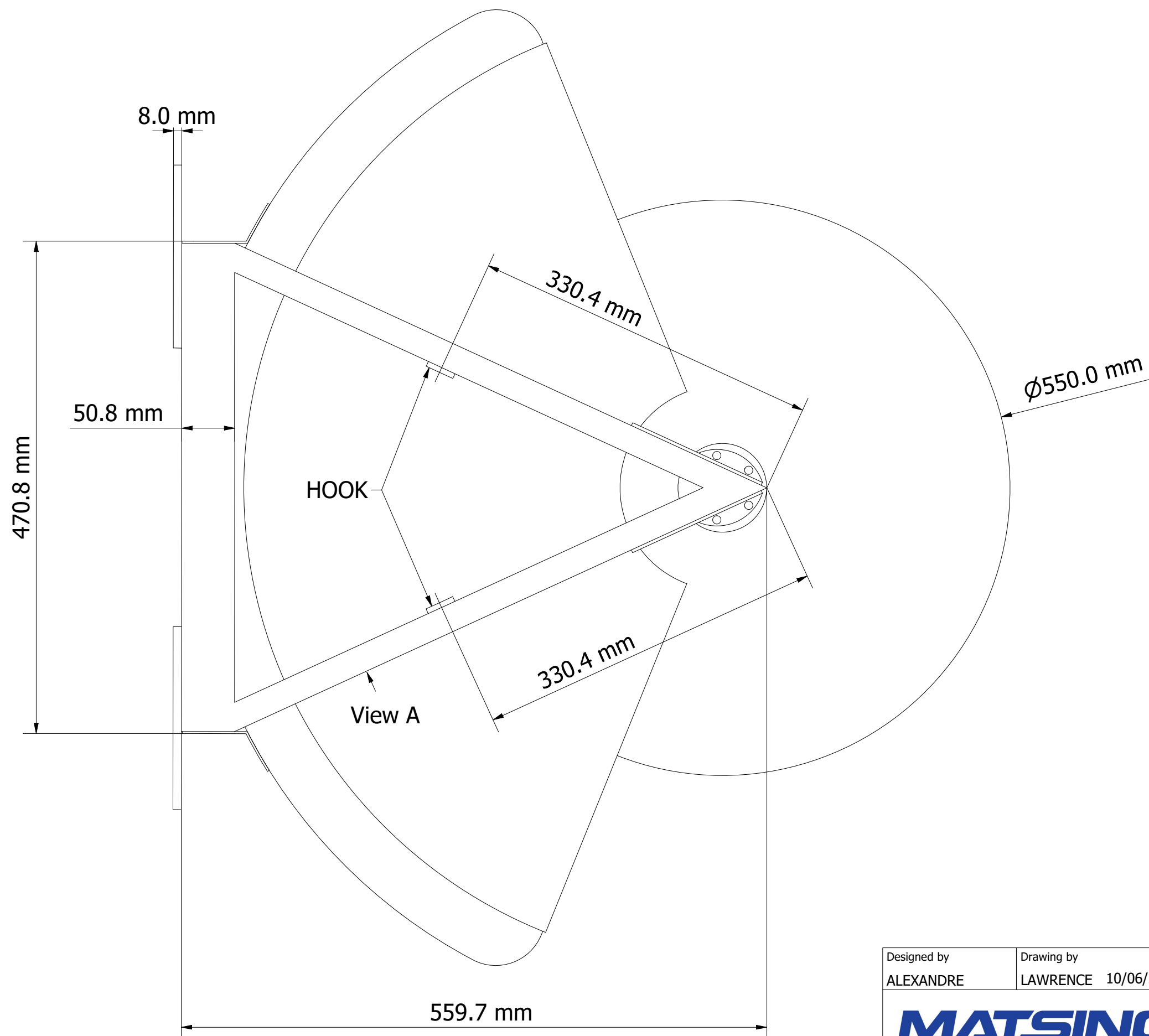

Designed by	Drawing by	Date	Approved by	Date	Quantity	Material
ALEXANDRE	LAWRENCE	10/06/2021	PAVEL	11/06/2021		
MATSING						MS-8H60
LENS TECHNOLOGY ENABLED						MS-8H60 (mm)
					Revision	Sheet
					1.5	5 / 6

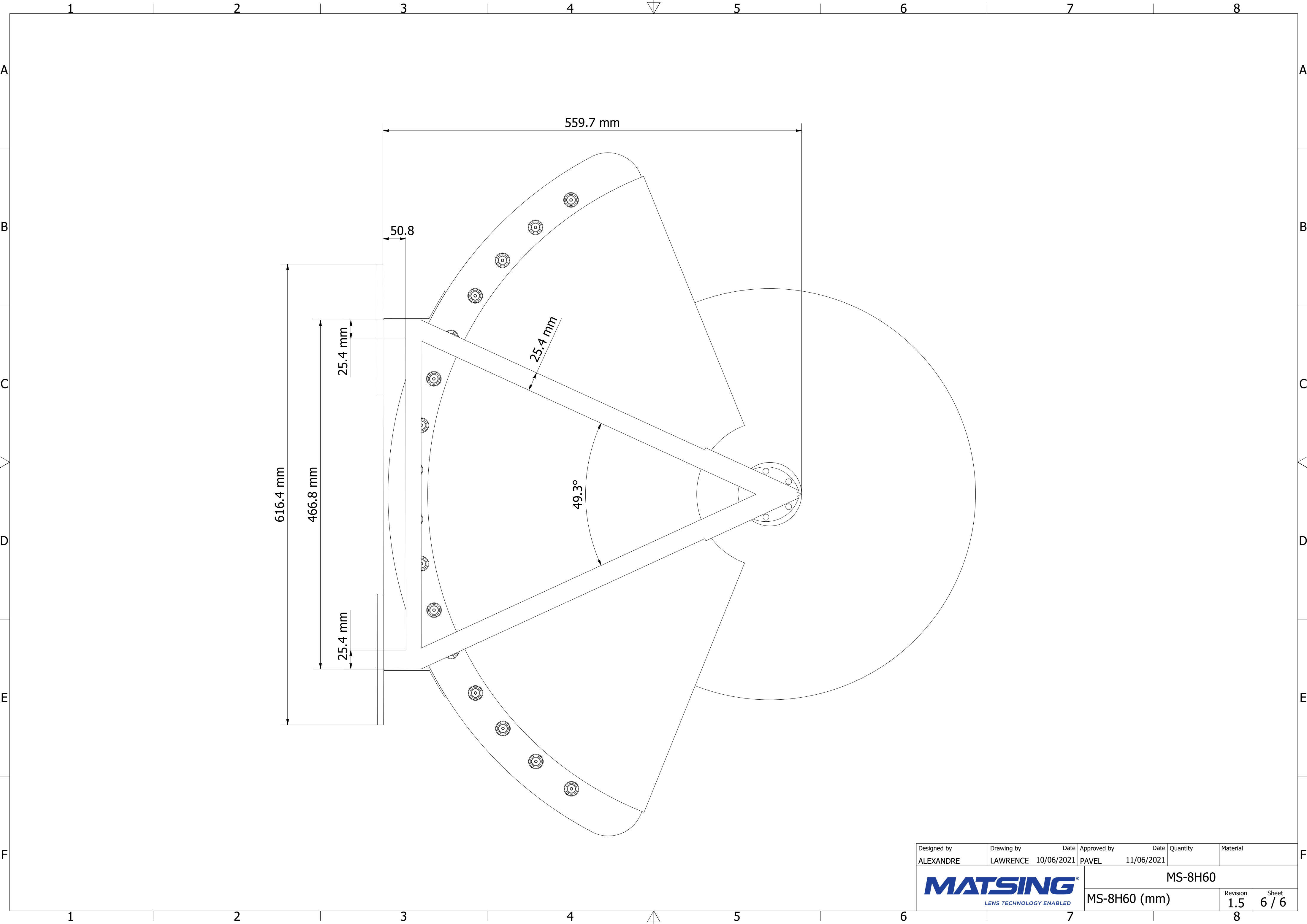

Designed by ALEXANDRE	Drawing by LAWRENCE	Date 10/06/2021	Approved by PAVEL	Date 11/06/2021	Quantity	Material
 MATSING <small>LENS TECHNOLOGY ENABLED</small>			MS-8H60			
			MS-8H60 (mm)			Revision 1.5