

Designed by VIGNESH	Drawing by LAWRENCE	Date 10/9/2024	Approved by PAVEL	Date 19/9/2024	Quantity	Material
<b>MATSING</b> LENS TECHNOLOGY ENABLED						MS-18C45
MS-18C45 (mm)					Revision 1.0	Sheet 1 / 6

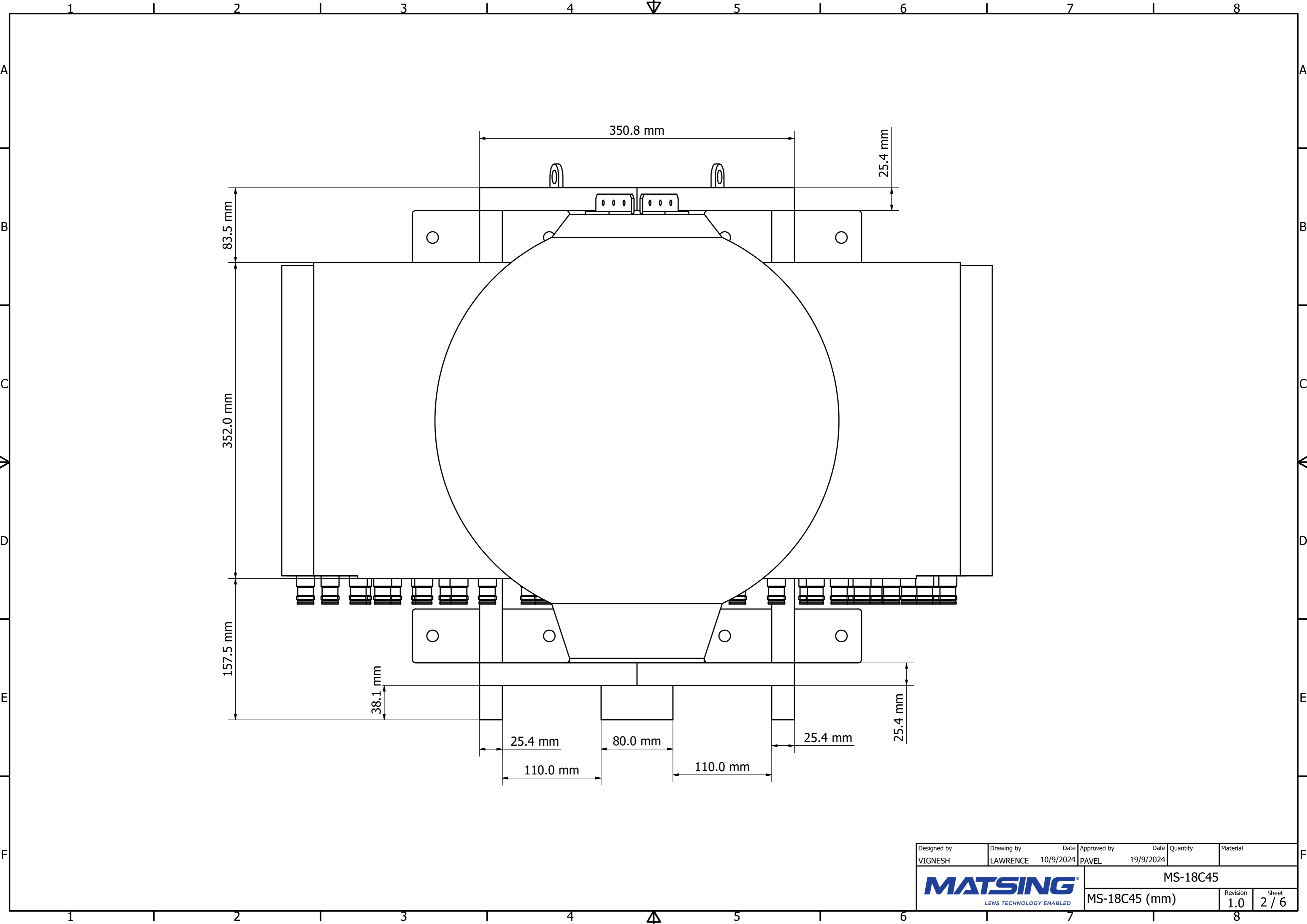

Designed by VIGNESH	Drawing by LAWRENCE	Date 10/9/2024	Approved by PAVEL	Date 19/9/2024	Quantity	Material
<b>MATSING</b> LENS TECHNOLOGY ENABLED						MS-18C45
MS-18C45 (mm)					Revision 1.0	Sheet 2 / 6

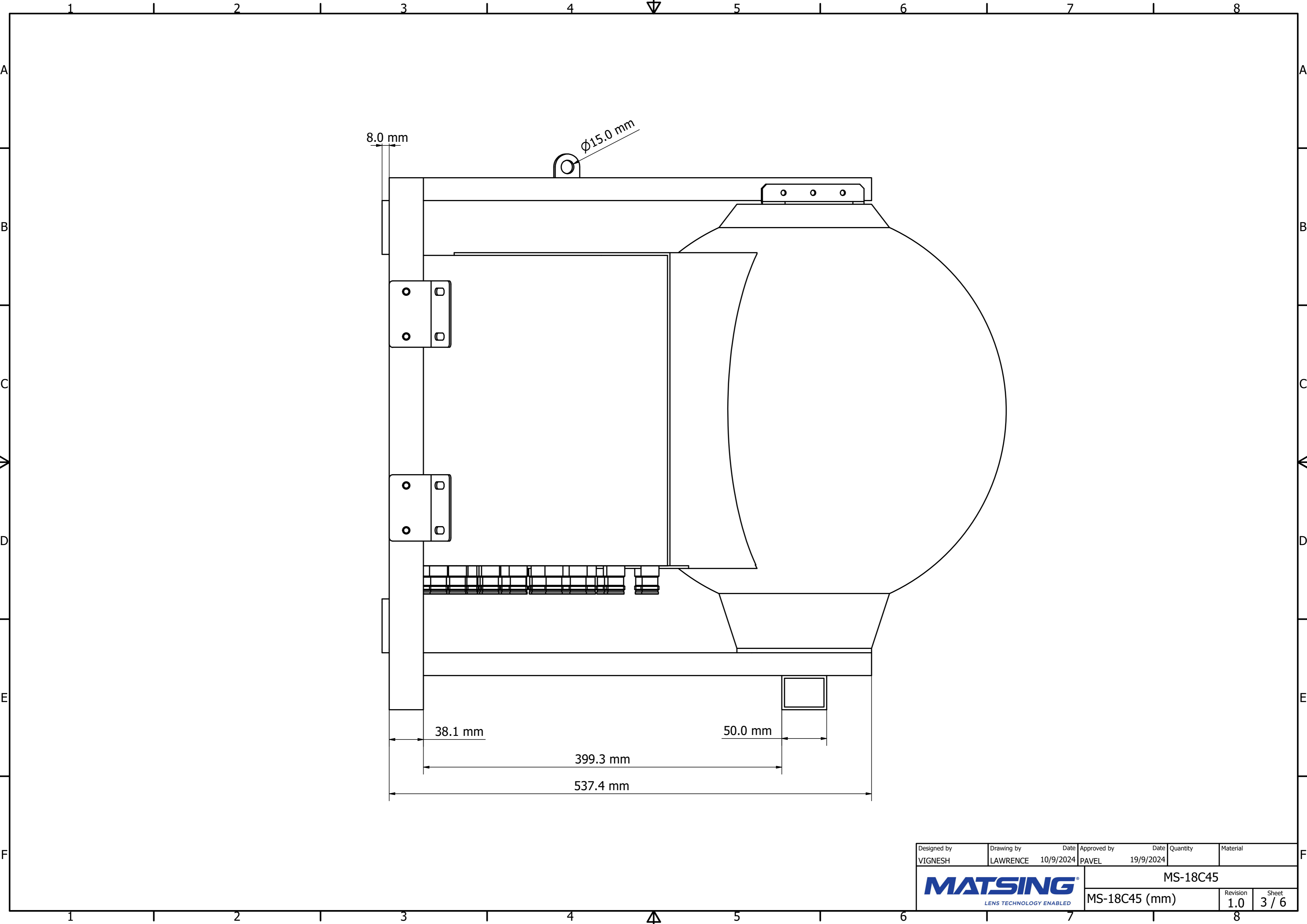

Designed by VIGNESH	Drawing by LAWRENCE	Date 10/9/2024	Approved by PAVEL	Date 19/9/2024	Quantity	Material
<b>MATSING</b> LENS TECHNOLOGY ENABLED						MS-18C45
MS-18C45 (mm)					Revision 1.0	Sheet 3 / 6

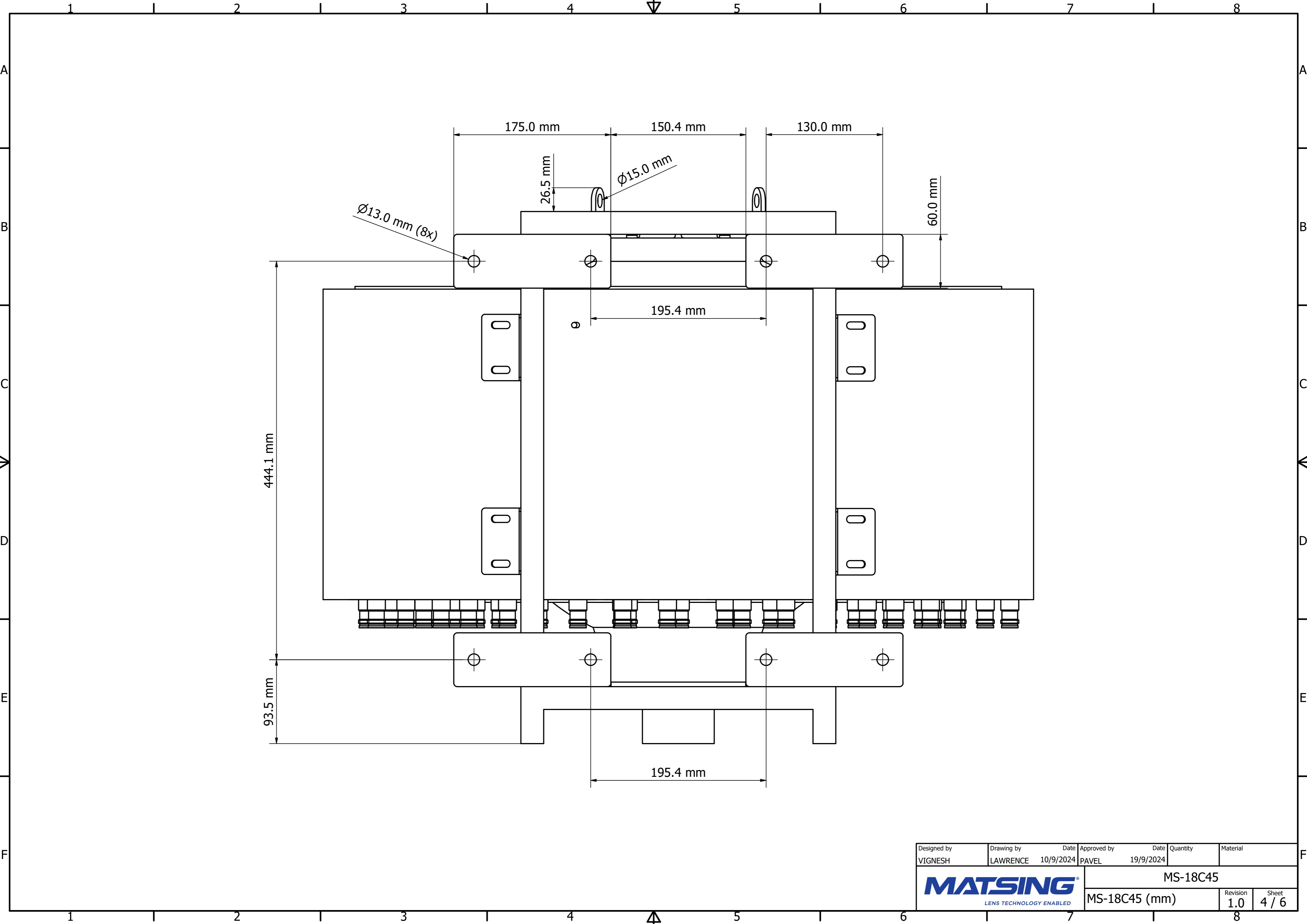

Designed by VIGNESH	Drawing by LAWRENCE	Date 10/9/2024	Approved by PAVEL	Date 19/9/2024	Quantity	Material
						MS-18C45
						MS-18C45 (mm)

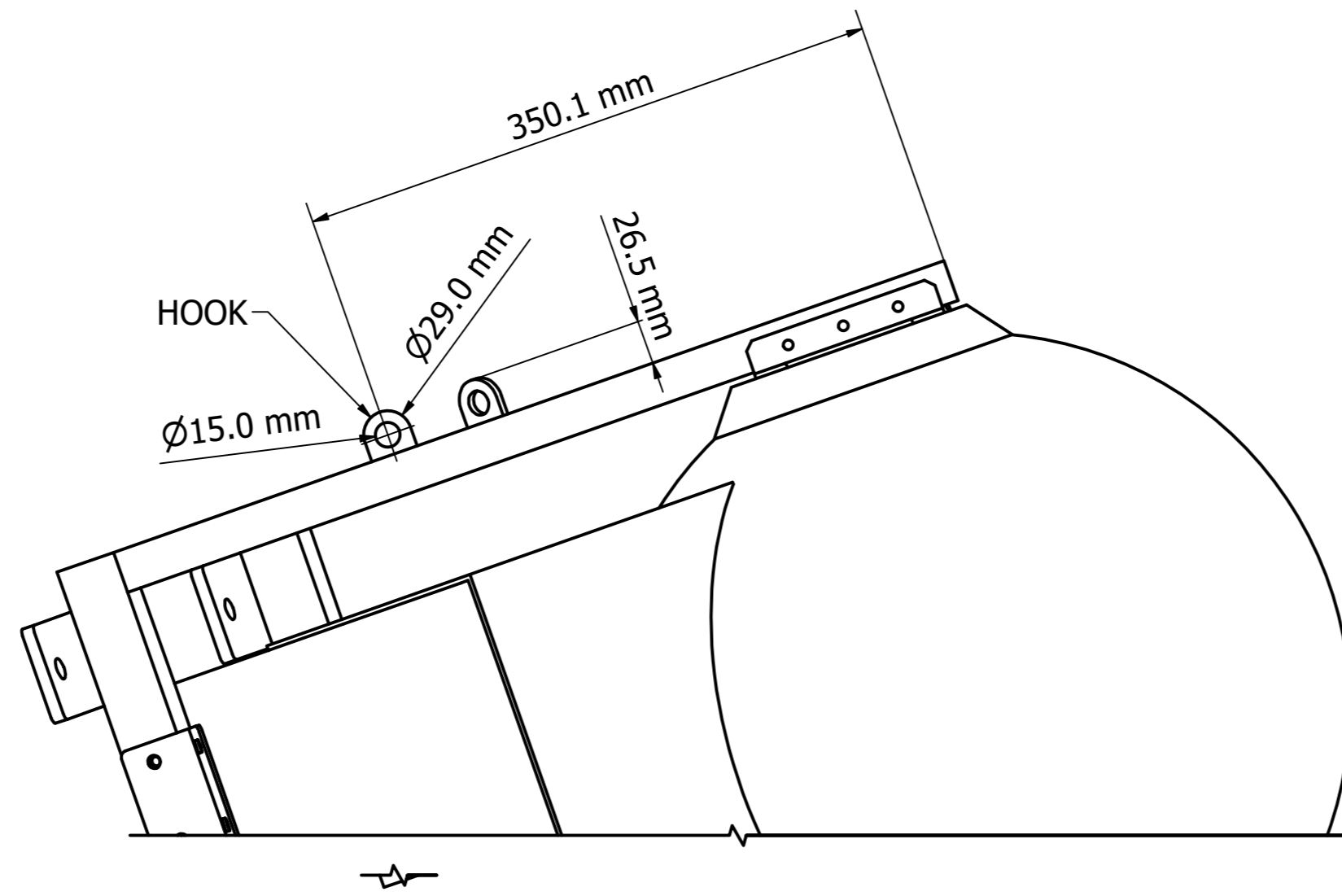

View A

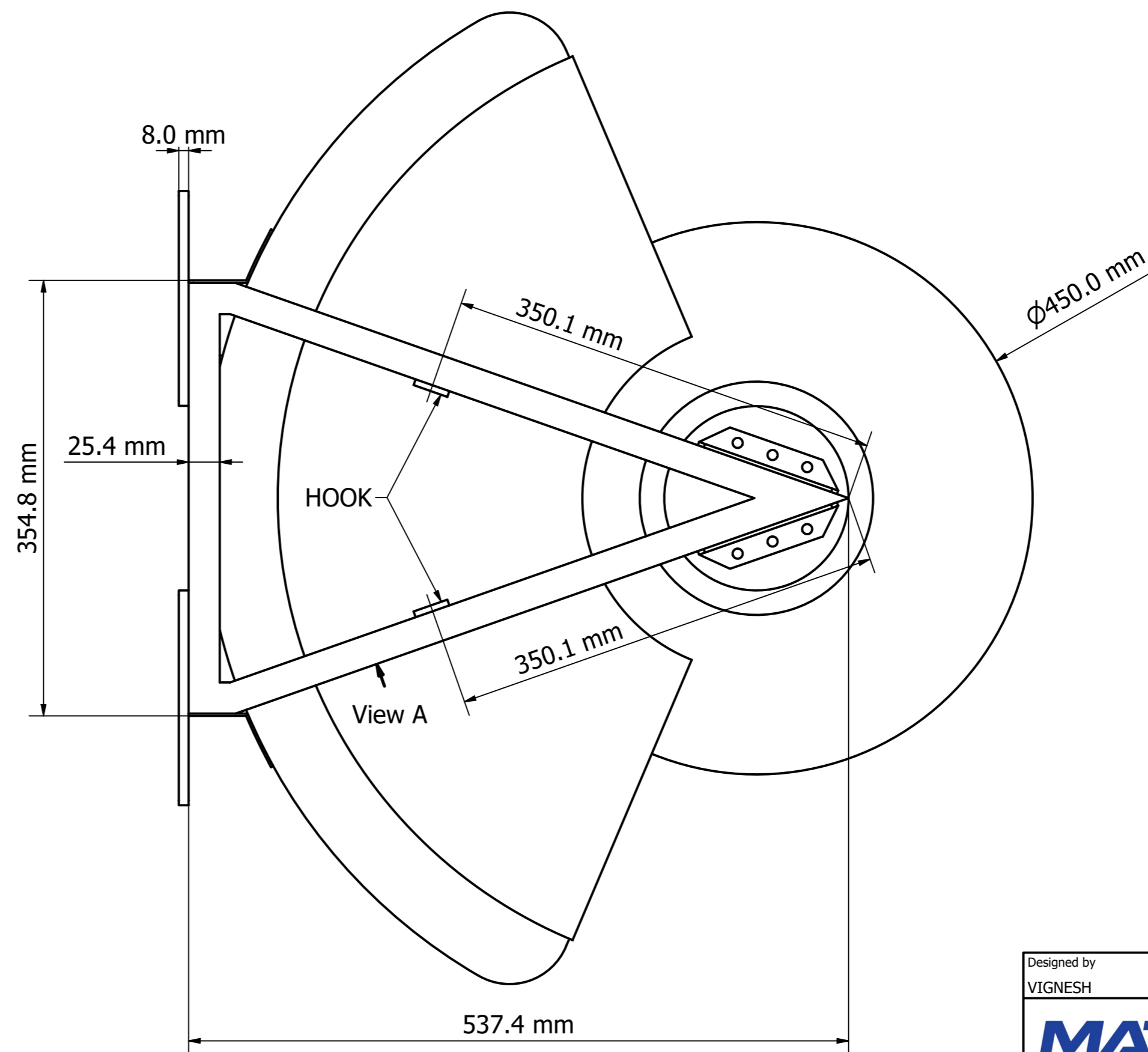

View A

Designed by VIGNESH	Drawing by LAWRENCE	Date 10/9/2024	Approved by PAVEL	Date 19/9/2024	Quantity	Material
<b>MATSING</b> LENS TECHNOLOGY ENABLED						MS-18C45
MS-18C45 (mm)					Revision 1.0	Sheet 5 / 6

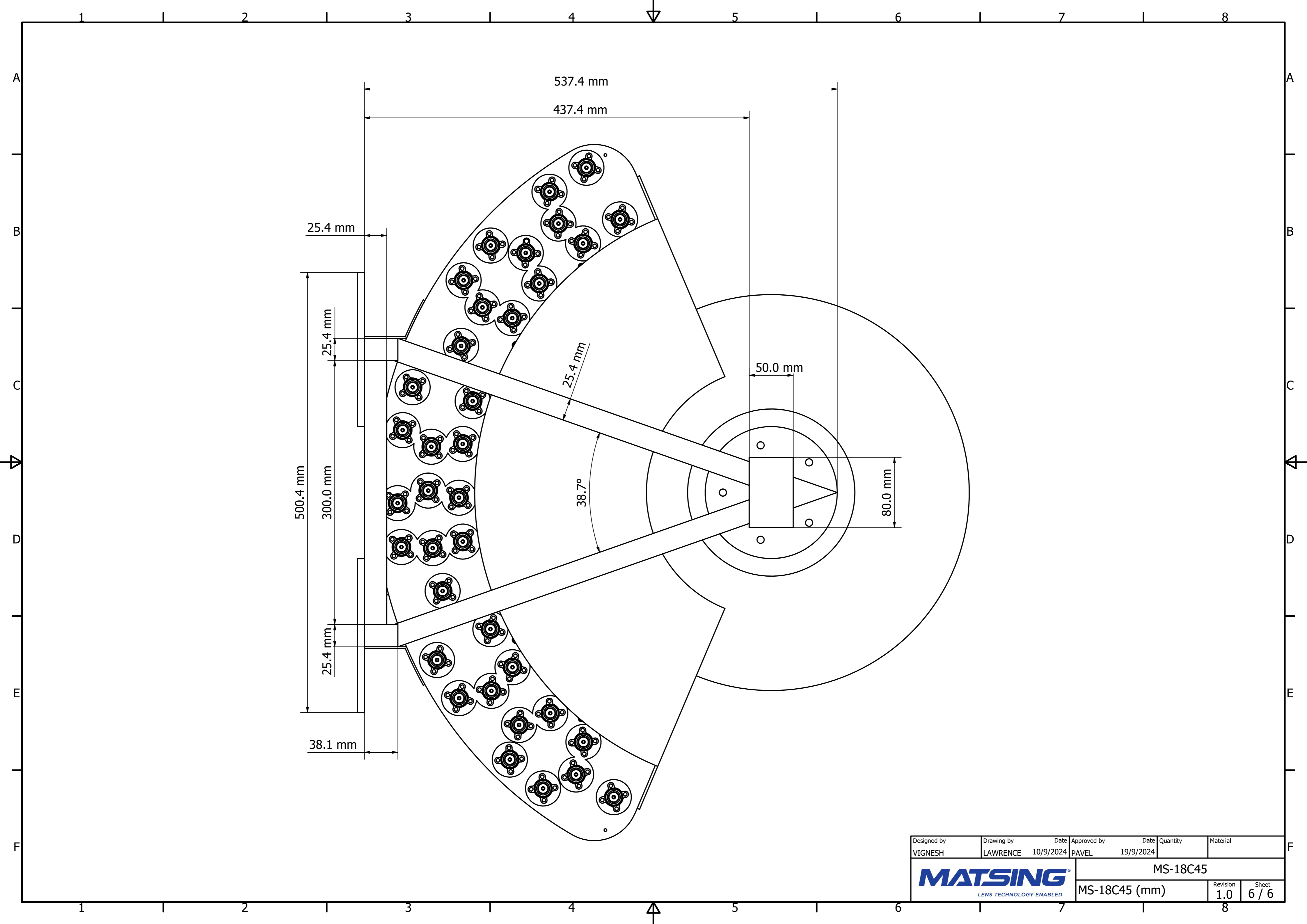

Designed by VIGNESH	Drawing by LAWRENCE	Date 10/9/2024	Approved by PAVEL	Date 19/9/2024	Quantity	Material
<b>MATSING</b> LENS TECHNOLOGY ENABLED						MS-18C45
MS-18C45 (mm)					Revision 1.0	Sheet 6 / 6